

## Operating Instructions

# Sartorius Competence | CP Series | Sartorius Gem<sup>plus</sup>

CP, GC and GP Models

Electronic Micro- and Analytical Precision Balances and Precious Metal Scales

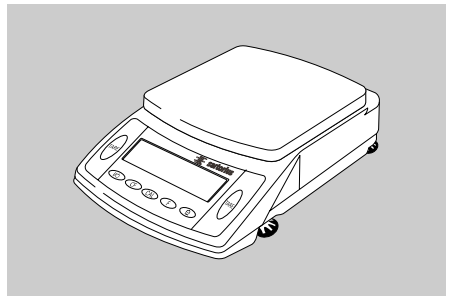
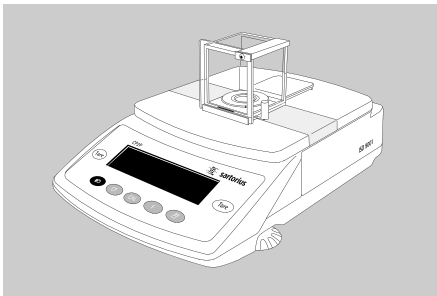
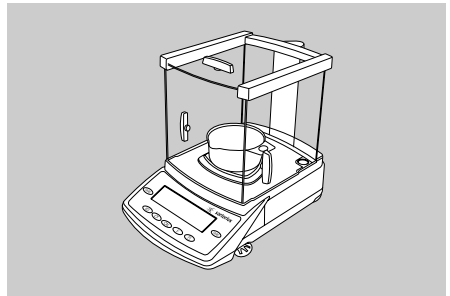
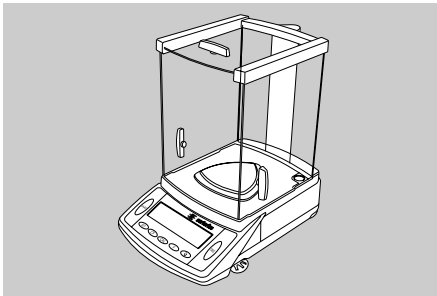
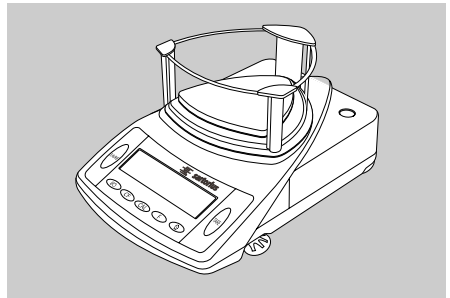
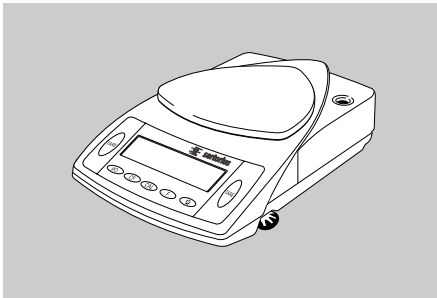

---

# Contents

2	<b>Contents</b>	50	<b>Generating a Printout</b>
3	<b>Intended Use</b>	53	ISO/GLP-compliant Printout
4	<b>Warnings and Safety Precautions</b>	55	<b>Data Interface</b>
5	<b>Getting Started</b>	59	Data Input Format
15	<b>Operation</b>	62	Pin Assignment Chart
15	Overview of Display and Operating Elements	63	Cabling Diagram
16	Basic Weighing Function	64	<b>Error Codes</b>
18	Below-Balance/Under-Scale Weighing	65	<b>Preparing CP2P.. Models for Transport</b>
20	Calibration/Adjustment	66	<b>Care and Maintenance</b>
24	<b>Configuration</b>	68	<b>Instructions for Recycling</b>
24	Printing the Settings	69	<b>Overview</b>
25	Setting the Parameters (Menu Codes)	69	Specifications
26	Parameter Settings (Overview)	82	Accessories (Options)
31	Setting IDs, Time, Date and Display Brightness	85	Declaration of Conformity
34	<b>Application Programs</b>	89	Plates and Markings
35	Net-Total Formulation		
39	Counting		
40	Reference Weighing		
43	Weighing in Percent		
46	Animal Weighing/Averaging		
49	Toggle between Weight Units		

---

## Intended Use

The models of the CP, GP and GC Series are weighing instruments of special and high accuracy designed for the measurement of mass, covering a range from 0.001 mg to 34 kg.

CP, GP and GC models meet the highest requirements on the accuracy and reliability of weighing results through the following features:

- Efficient filtering-out of unfavorable ambient conditions, such as vibration, drafts, etc.
- Stable and reproducible weighing results
- Excellent readability under any lighting conditions
- Rugged, durable weighing system

These weighing instruments save work and speed up simple routine applications through these features:

- Extremely fast response times
- Built-in applications (counting, net-total formulation, animal weighing, weighing in percent, etc.)
- Total ease of operation
- ISO/GLP-compliant recording capability for printouts
- Serial RS-232 port for optional connection to a PC

# Warnings and Safety Precautions

The balance/scale has been constructed in accordance with the European Directives as well as international regulations and standards for operation of electrical equipment, electromagnetic compatibility, and stipulated safety requirements. Improper use or handling, however, can result in damage and/or injury.

To prevent damage to the equipment, please read these operating instructions carefully before using your balance/scale. Keep these instructions in a safe place. Follow the instructions below to ensure safe and trouble-free operation of your balance/scale:

⚠ Do not use this balance/scale in a hazardous area/location.

⚠ If you use electrical equipment in installations and under ambient conditions requiring higher safety standards, you must comply with the provisions as specified in the applicable regulations for installation in your country.

⚠ Make sure that the voltage rating printed on the AC adapter is identical to your local line voltage.

⚠ Warning when using pre-wired RS-232 connecting cables: The pin assignments in RS-232 cables purchased from other manufacturers may be incompatible with Sartorius balances/scales. Be sure to check the pin assignment against the chart on page 62 before connecting the cable, and disconnect any lines marked "Internally Connected."

– The only way to switch the power off completely is to disconnect the AC adapter.

– Connect only Sartorius accessories and options, as these are optimally designed for use with your Sartorius balance/scale.

– Note on Installation:

The operator shall be responsible for any modifications to Sartorius equipment and for any connections of cables or equipment not supplied by Sartorius and must check and, if necessary, correct these modifications and connections. On request, Sartorius will provide information on the minimum operating specifications (in accordance with the Standards for defined immunity to interference).

IP ratings:

- CP34001S, CP34001P, CP34000, CP16001S and CP12001S meet IP44 requirements
- Additional models with readabilities  $\geq 10$  mg meet IP53 requirements
- Models with readabilities  $\leq 1$  mg meet IP32 requirements
- AC adapters meet IP20 requirements

– Protect the AC adapter and the weighing instrument from contact with liquids.

When cleaning your balance/scale, make sure that no liquid enters the balance/scale housing; use only a slightly moistened cloth to clean the balance/scale.

Do not open the balance/scale housing. If the seal is broken, this will result in forfeiture of all claims under the manufacturer's warranty. If you have any problems with your balance/scale:

- Contact your local Sartorius office, dealer or service center

---

# Getting Started

## Storage and Shipping Conditions

Do not expose the balance/scale to extreme temperatures, blows, shocks, vibration or moisture.

## Unpacking the Equipment

- After unpacking the balance/scale, check it immediately for any visible damage as a result of rough handling during shipment
- If you see any sign of damage: proceed as directed in the section on “Safety Inspection” in the chapter entitled “Care and Maintenance.”

It is a good idea to save the box and all parts of the packaging until you have successfully installed your balance/scale. Only the original packaging provides the best protection for shipment.

Before packing your balance/scale, unplug all connected cables to prevent damage.

## Equipment Supplied

The equipment supplied includes the components listed below:

- CP2P, CP2P-F
  - Balance with display and control unit
  - Kit of standard accessories
  - AC adapter
  - Dust cover
  - Gem tray (GC scales only)
  - Filter pan and lid
  - Spacer (model CP2P-F only)
- The kit of standard accessories contains the following:
- Weighing pan
  - Interior draft shield
  - Hanger for below-balance weighing
  - 1 brush
  - 1 pair of forceps
  - 1 piece of lint-free cloth

## Equipment Supplied

The equipment supplied includes the components listed below:

CP Balances with Readability of  $\leq 0.1$  mg;  
CP...-DS Scales, GC Scales

- Balance/scale with display and control unit
- Electronics box (model CP225D only)
- Draft shield with base plate (not available for the CP64-WDS)
- AC adapter
- Weighing pan
- Shield disk (not available for CP...-DS models)
- Dust cover
- Gem tray (GC scales only)

CP Balances with Readability of 1 mg  
(except for the CP...-DS models)

- Balance with display and control unit
- Draft shield with cover
- AC adapter
- Weighing pan
- Pan support
- Base plate

CP Balances with Readability of  
0.01 g/0.1 g, GP Scales

- Balance/scale with display and control unit
- AC adapter
- Weighing pan
- Pan support (model CP622 only)
- Gem tray (GP scales only)

CP34001S, CP34001P, CP16001S,  
CP12001S, CP34000

- Balance with display and control unit
- AC adapter
- Weighing pan

## Installation Instructions

Your balance/scale is designed to provide reliable weighing results under normal ambient conditions. When choosing

a location to set up your balance/scale, observe the following so that you will be able to work with added speed and accuracy:

- Set up the balance/scale on a stable, even surface
- Avoid placing the balance/scale in close proximity to a heater or otherwise exposing the balance/scale to heat or direct sunlight
- Protect the balance/scale from drafts that come from open windows or doors
- Avoid exposing the balance/scale to extreme vibrations during weighing
- Protect the balance/scale from aggressive chemical vapors
- Do not expose the balance/scale to extreme moisture over long periods
- Level the balance/scale at the place of installation

## Conditioning the Balance/Scale:

Moisture in the air can condense on the surfaces of a cold balance/scale whenever it is brought into a substantially warmer place. If you transfer the balance/scale to a warmer area, make sure to condition it for about 2 hours at room temperature, leaving it plugged into AC power.

## Seal on Balances/Scales Verified for Use in Legal Metrology in the EU\*:

EU legislation requires that a control seal be affixed to verified balances/scales of accuracy class  $\text{II}$ . The control seal consists of a sticker with the "Sartorius" logo. This seal will be irreparably damaged if you attempt to remove it. If the seal is broken, the validity of verification will become void and you must have your balance/scale re-verified.

\* Including the Signatories of the Agreement on the European Economic Area

# Setting up the Balance/Scale

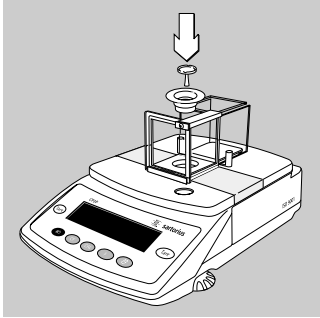

## Model CP2P

- Remove the adhesive tape from the chamber doors
- Place the components listed below inside the chamber in the order given:
  - Interior draft shield
  - Weighing pan

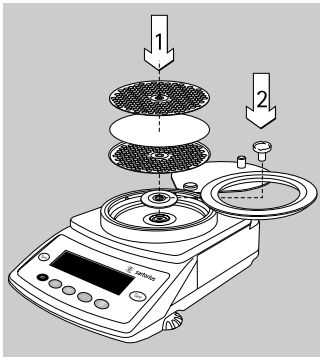

## Model CP2P-F

1) Weighing filters of up to 125 mm Ø:

- Lift the chamber lid gently and turn it to the left or right
- Place the components listed below inside the chamber in the order given:
  - Interior draft shield
  - Filter pan
  - Cover the sample (filter) with the lid

or

2) Weighing with the standard weighing pan (20 mm Ø):

- Lift the chamber lid gently and turn it to the left or right
- Place the components listed below inside the chamber in the order given:
  - Interior draft shield
  - Spacer ring
  - Weighing pan

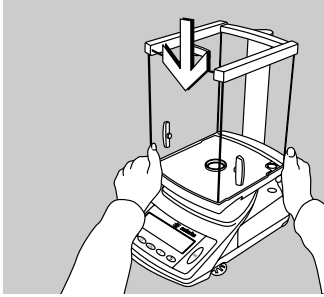

**Balances/Scales with an Analytical Draft Shield Chamber:**

△ Move the sliding lock on the back of the draft shield to the right (open position)

● Position the draft shield carefully on the balance/scale

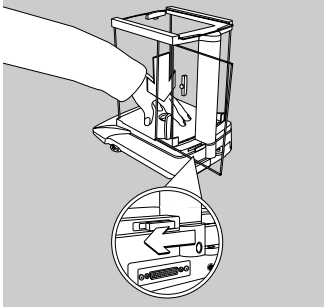

● Secure the draft shield in position by moving the sliding lock device on the back of the balance/scale to the left while pressing down gently on the floor of the draft shield

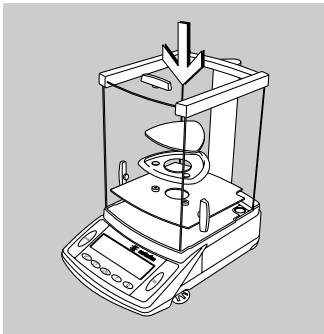

● Place the components listed below inside the chamber in the order given:

- Base plate
- Shield disk (not available for CP...-DS models)
- Weighing pan
- Gem tray (GC models only)





### Connecting the Electronics Box to Model CP225D (-OCE)

- Insert the connector on the cable in to the socket on the electronics box

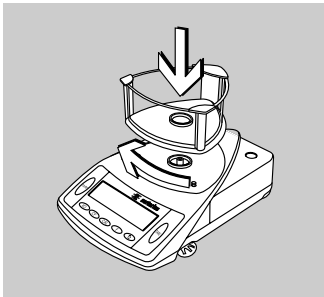

### Balances/Scales with a 3-sided Draft Shield:

- Place the draft shield on the balance/scale with the cover opening in front on the right
- Turn the draft shield clockwise until it is firmly in position

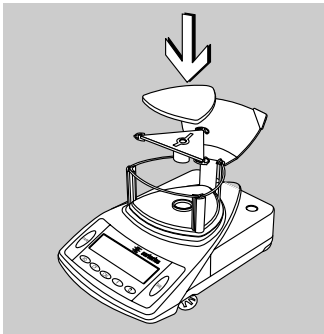

- Place the components listed below inside the chamber in the order given:
  - Base plate
  - Pan support
  - Weighing pan
- Accessing the weighing chamber from the side: Pull out the side panels one at a time

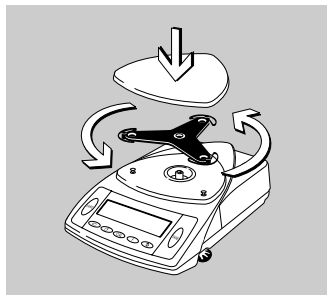

#### **CP622**

- Place the components listed below on the balance/scale in the order given:
  - Pan support
  - Weighing pan

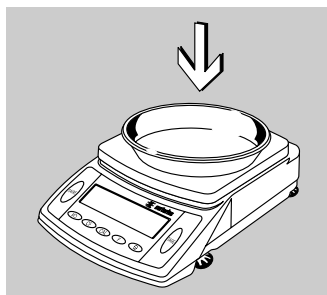

#### **Balances/Scales with a Rectangular Weighing Pan and a Weighing Capacity of up to 10 kg**

- Place the components listed below on the balance/scale in the order given:
  - Weighing pan
  - Gem tray (GP scales only)

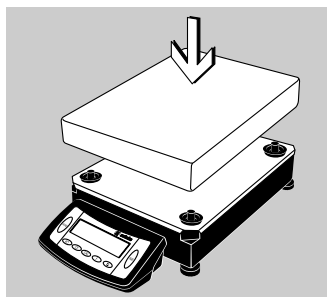

#### **Balances/Scales with a Rectangular Weighing Pan and a Weighing Capacity over 10 kg**

- Place the weighing pan on the balance/scale

#### **Connecting the Balance/Scale to AC Power/Safety Precautions**

- Use only original Sartorius AC adapters. The protection rating on the AC adapter is IP20 in accordance with EN60529.
- See “Accessories” for information on using an IP65-protected industrial AC adapter or an external rechargeable battery pack with your balance/scale.

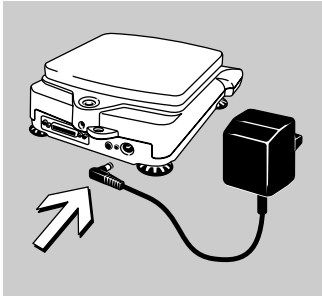

**CP225D:**

- Insert the right-angle plug into the jack on the electronics box

All Other Balances/Scales with a Weighing Capacity of up to 10 kg:

- Insert the right-angle plug into the jack on the balance/scale

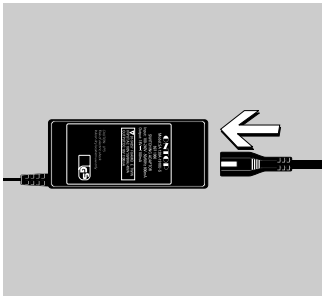

Connect the power cable to the AC adapter (on balances/scales with weighing capacities of up to 10 kg)

- Use an original Sartorius AC adapter with a wide input voltage range (100 ... 240 V~), order number 6971966, and replaceable power cable:
  - 6900900 (Europe)
  - 6900901 (US/CDN)
  - 6971945 (UK)
  - 6900905 (AUS)
  - 6900902 (ZA)

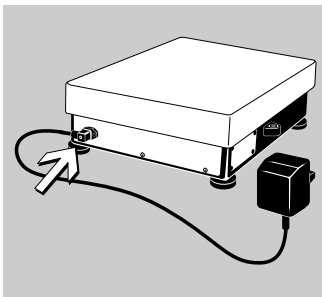

Balances/Scales with a Weighing Capacity of over 10 kg:

- Insert the right-angle plug into the jack and tighten the screw.

---

## Safety Precautions

### Balance/scale-specific AC adapter:

The AC adapter rated to Class 2 can be plugged into any wall outlet without any additional safety precautions.

### Model 6971966 universal AC adapter:

The AC adapter rated to Class 1 can be plugged into any wall outlet using a protective bonding conductor (= grounding) without any additional safety precautions. The ground or earth terminal is connected to the balance/scale housing, which can be additionally grounded, if required. The data interface is also electrically connected to the balance/scale housing (ground).

### Note:

This equipment has been tested and found to comply with the limits pursuant to part 15 of FCC Rules. These limits are designed to provide reasonable protection against harmful interference. This equipment generates, uses and can radiate radio frequency energy and, if not installed and used in accordance with these instructions, may cause harmful interference to radio communications.

For information on the specific limits and class of this equipment, please refer to the Declaration of Conformity. Depending on the particular class, you are either required or requested to correct the interference.

If you have a Class A digital device, you need to comply with the FCC statement as follows: "Operation of this equipment in a residential area is likely to cause harmful interference in which case the user will be required to correct the interference at his own expense."

If you have a Class B digital device, please read and follow the FCC information given below:

However, there is no guarantee that interference will not occur in a particular installation. If this equipment does cause harmful interference to radio or television reception, which can be determined by turning the equipment off and on, the user is encouraged to try to correct the interference by one or more of the following measures:

- Reorient or relocate the receiving antenna.
- Increase the separation between the equipment and receiver.
- Connect the equipment into an outlet on a circuit different from that to which the receiver is connected.
- Consult the dealer or an experienced radio/TV technician for help.

Before you operate this equipment, check which FCC class (Class A or Class B) it has according to the Declaration of Conformity included. Be sure to observe the information of this Declaration.

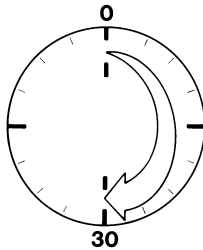
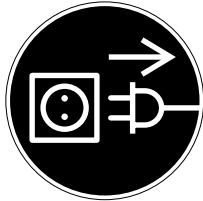

### Connecting Electronic Peripheral Devices

- Make absolutely sure to unplug the balance/scale from AC power before you connect or disconnect a peripheral device (printer or PC) to or from the interface port.

### Warmup Time

To deliver exact results, the balance/scale must warm up as listed below after initial connection to AC power or after a relatively long power outage.

- Model CP2P microbalance: at least 4 hours
- All other precision and analytical models: at least 30 minutes

Only after this time will the balance/scale have reached the required operating temperature.

Using Verified Balances/Scales as Legal Measuring Instruments in the EU\*

- The balance/scale must warm up for at least 24 hours after initial connection to AC power.

### Leveling the Balance/Scale

Purpose

- To compensate for unevenness at the place of installation.
- To achieve perfectly horizontal positioning of the balance/scale for consistent reproducibility

Always level the balance/scale again after any time it has been moved.

\* including the Signatories of the Agreement on the European Economic Area

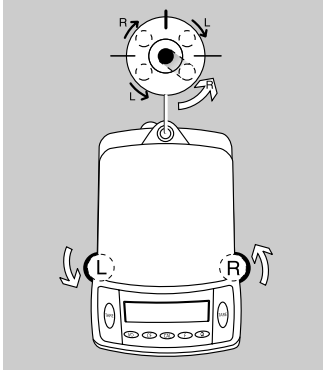

### Leveling Balances/Scales with a Weighing Capacity of up to 10 kg

Only the 2 front feet are used for leveling.

- Retract the 2 rear feet (on models with rectangular weighing pans only).
  - Turn the 2 front feet as shown in the diagram until the air bubble is centered within the circle of the level indicator.
- > In most cases this will require several adjustment steps

- For weighing heavy samples:  
Extend the 2 rear feet until they touch the surface on which the balance/scale rests (on models with rectangular weighing pans only).

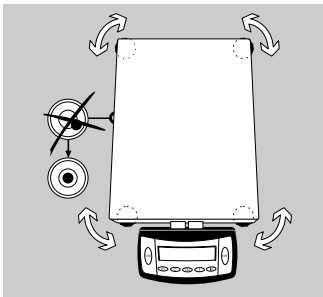

### Leveling Balances/Scales with a Weighing Capacity over 10 kg

- Adjust the leveling feet until the air bubble is centered within the circle of the level indicator

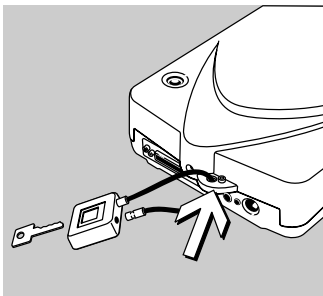

### Antitheft Locking Device on Balances/Scales with a Weighing Capacity of up to 10 kg



To fasten an antitheft locking device, use the lug located on the rear panel of the balance/scale.

- Secure the balance/scale at the place of installation, e.g., with a chain or a lock.

# Operation

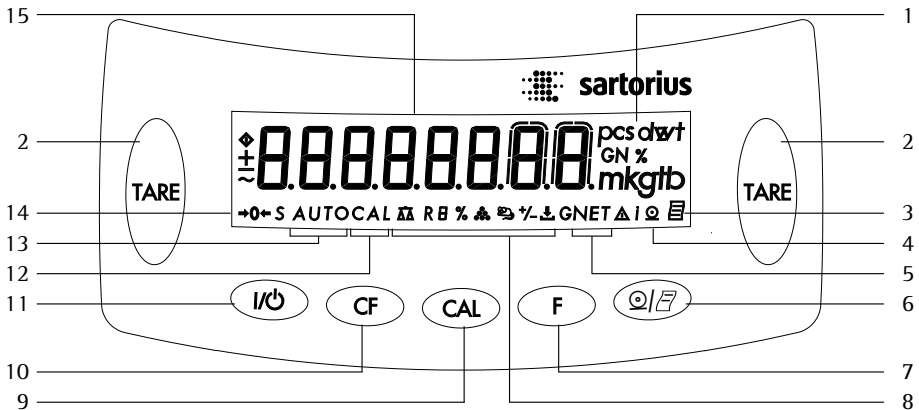
## Overview of Display and Operating Elements



Designation	Description	Designation	Description
1	Weight units	10	Delete (Clear Function)
2	Tare function: Press here to tare the weight of any container so that the readout shows the net weight of samples.		This key is generally used to interrupt/cancel functions; for example: – to end an application program – to interrupt calibration/adjustment routines
3	Symbol indicating that a GLP-compliant printout is being generated	11	On/Off key: Switches the display on/off. (The balance/scale may remain in standby mode, depending on the settings.)
4	Symbol indicating that a printout is being generated	12	Symbol indicating that the calibration/adjustment function is active
5	Symbol indicating data in memory, when using the net-total formulation program	13	Symbol indicating that the animal weighing program is active, with automatic-start function
6	Data output function (  /  ) Press this key to send displayed values over the built-in data interface to a DataPrint printer or a PC.	14	Symbol indicating stand-by mode or zero range
7	Function key: Starts an application program	15	Weight readout in the selected weight unit
8	Symbol indicating the active program		
9	Press here to start calibration/adjustment		

# Basic Weighing Function

## Purpose

The basic weighing function is always accessible and can be used alone or in combination with an application program (counting, weighing in percent, etc.).

## Features

- Taring the balance/scale  
You can tare the balance/scale within the entire weighing range.
- Assigning IDs to weights (as needed)
- Printing weights

## Using Verified Balances/Scales as Legal Measuring Instruments in the EU\*

The type-approval certificate for verification applies only to non-automatic weighing instruments; for operation with or without auxiliary measuring devices, you must comply with the regulations of your country applicable to the place of installation of your balance/scale.

- Before using the balance/scale as a legal measuring instrument, calibrate and adjust it at the place of use using the built-in motorized calibration and adjustment weight (span adjustment device): see the “Calibration/Adjustment” section in this chapter
- The temperature range (°C) indicated on the verification label may not be exceeded during operation

Example:

BD BL 200

Ⓜ +10 ... +30°C

## Working with CP2P... Models:

Working with the microbalance requires a steady hand and a smooth, uninterrupted technique.

Use forceps or other suitable utensil to place the sample on the weighing pan.

Perform a number of test measurements before you begin weighing, to allow the temperature inside the weighing chamber to adjust to the ambient temperature outside the chamber. Otherwise, if the chamber door was closed for a long period of time prior to beginning weighing, the sudden change in temperature inside the chamber when you open the door might affect the weight readout. This is why we recommend starting with a series of test measurements; the repeated opening and closing of the weighing chamber door, at the same rate as you will be doing during the actual weighing sequence, will both compensate this difference in temperature to some extent and help you develop a smooth working rhythm.

Place the sample gently on the weighing pan. The weight readout should stabilize within 15 to 20 seconds.

The degree of precision attained increases in proportion as each weighing operation in a sequence of measurements becomes more identical.

\* including the Signatories of the Agreement on the European Economic Area



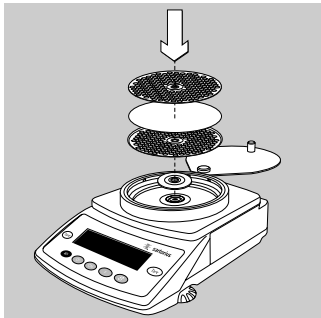
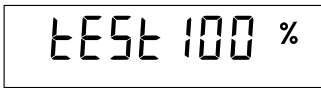
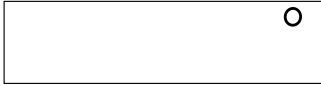

### Preparation

A circle displayed in the upper right-hand corner indicates that the balance/scale has been disconnected from power (the power cable was unplugged or due to power failure).

- Turn on the balance/scale: Press  $\text{I/O}$
- > All symbols on the display light up briefly.
- > The balance/scale performs a display test.
- To change configurations: see the chapter entitled “Configuration”
- To load factory-set default configurations: see “Configuration” (menu code 9 - - !)

- To tare the balance/scale: Press  $\text{TARE}$   
When the balance/scale is switched on, the  $\diamond$  is displayed until you press a key. If the  $\diamond$  symbol is displayed during operation, this indicates that the processor is performing a function and cannot receive further commands at the moment.

### Additional Functions

- Turning off the balance/scale: Press  $\text{I/O}$   
A zero in the lower left-hand corner indicates that the balance/scale has been switched off and is in stand-by mode.

### Filter Weighing with Model CP2P-F

The CP2P-F filter microbalance comes with a filter pan that has a utilizable diameter of 125 mm as standard equipment. Place the filter on the pan and close the lid.

## Analytical and Precision Balances:

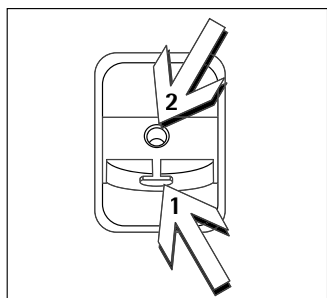
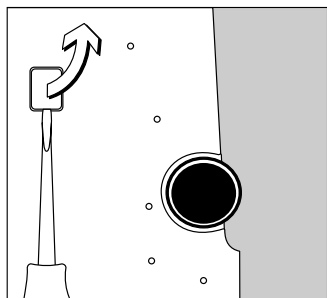

## Below-Balance/Under-Scale Weighing

A port for a below-balance/under-scale weighing hanger is located on the bottom of the balance/scale. You can order the hanger directly from Sartorius for balances/scales with a weighing capacity over 12 kg (see "Accessories").

- Open cover plate on the bottom of the balance/scale.
- Using the built-in hanger (1): Attach the sample (e.g., using a suspension wire) to the hanger
- Bore hole (2): Carefully fasten the special hanger, or order a hanger directly from Sartorius.
- If necessary, install a shield for protection against drafts

## Important Note Concerning Verified Balances/Scales Approved for Use as Legal Measuring Instruments in the EU\*:

The below-balance/under-scale weighing port may not be opened or used when an approved balance/scale is being operated as a legal measuring instrument.

## Microbalance CP2P..:

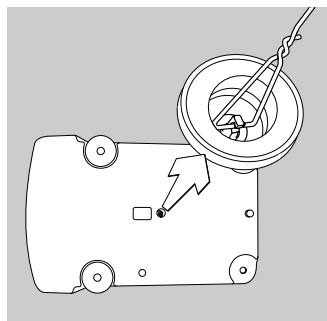









- Remove the brass screw
- Suspend the below-balance weighing hook supplied from the hanger
- If necessary, install a shield for protection against drafts

\* including the Signatories of the Agreement on the European Economic Area

**Example**  
Simple Weighing

Setting in Balance/Scale Operating Menu: Line format for printout:  
For other applications/GLP (7 2 2)

Step	Key (or instruction)	Display/Printout
1. Turn on the balance/scale Self-test is performed, followed by automatic initial tare function.		+ 0.0 g
2. Place container on balance/scale (in this example: 11.5 g).	 	+ 11.5 g
3. Tare the balance/scale.		+ 0.0 g
4. Place sample in container on balance/scale (in this example: 132 g).	 	+ 132.0 g
6. Print weight.	 / 	N + 132.0 g

# Calibration/Adjustment

## Purpose

Calibration is the determination of the difference between the weight readout and the true weight (mass) of a sample. Calibration does not entail making any changes within the balance/scale.

Adjustment is the correction of any difference between the measured value displayed and the true weight (mass) of the sample, or the reduction of the difference to an allowable level within the maximum permissible error limits.

## Using Verified Balances/Scales as Legal Measuring Instruments in the EU\*

Before using your balance/scale as a legal measuring instrument, you must perform “internal calibration” at the place of installation after the warmup period.

## Features

Calibration/adjustment can be performed only when

- there is no load on the balance/scale,
- the balance/scale is tared,
- the internal signal is stable.

If these conditions are not met, an error message is displayed (Err 02).

Adjustment can be performed

- automatically following calibration (menu code  $\uparrow$  00  $\downarrow$ ) or
- manually, at operator discretion, after calibration ( $\uparrow$  00  $\downarrow$ )

The weight displayed for the sample on the balance/scale must not differ from the nominal weight by more than 2%.

You can use any of the following weight units to calibrate/adjust: g, kg, lb ( $\uparrow$  11  $\downarrow$  3)

You can block calibration/adjustment of the balance/scale:

- Select menu code  $\uparrow$  9  $\downarrow$ , and
- Close the menu access switch on the back of the balance/scale

You can have the calibration/adjustment results documented in a ISO/GLP-compliant printout (see page 53).

## For service technicians only: External Calibration in Verified Balances/ Scales of Accuracy Class (II)

- External calibration can be made accessible only after removing the verification control seal.
- > In this case, the validity of the verification becomes void and the balance/scale must be re-verified.

\* including the Signatories of the Agreement on the European Economic Area

---

### Calibration/Adjustment Sequence

You can configure the operating menu so that:

- adjustment automatically follows calibration in a single operation (  $\uparrow$   $\rightarrow$   $\downarrow$  ), or
- the operator chooses whether to end the calibration/adjustment routine or have adjustment performed (  $\uparrow$   $\rightarrow$   $\downarrow$  )

If there is no deviation, or if the difference is within the effective requirements for accuracy of measurements, it is not necessary to adjust the balance/scale. In this case, you can end the calibration routine following calibration. Two keys are active at that point:

- $\text{CAL}$  = start adjustment
- $\text{CF}$  = end the calibration/adjustment routine

### Factory Settings

Calibration adjustment mode for models without built-in motorized calibration weight:

External calibration (  $\uparrow$   $\rightarrow$   $\downarrow$  )

Calibration adjustment mode for models with built-in motorized calibration weight:

Internal calibration (  $\uparrow$   $\rightarrow$   $\downarrow$  )

Calibration/adjustment sequence:

Adjustment automatically follows calibration in a single operation (  $\uparrow$   $\rightarrow$   $\downarrow$  )

Weight unit for calibration: grams (  $\uparrow$   $\downarrow$   $\downarrow$  )

ISO/GLP-compliant printout: off (  $\text{B}$   $\rightarrow$   $\downarrow$  )

### Internal Calibration (for models with built-in calibration weight only)





The built-in calibration weight is standard equipment on all verified balances/scales and on the following standard (non-verified) models:

CP2P., CP225D, CP324S, CP224S, CP64, GC1603P, GC803S, GC803P

Settings:

Calibration/adjustment mode: Internal calibration/adjustment (menu code  $\uparrow$  9  $\downarrow$ )

There is a motorized calibration weight within the balance/scale housing which is applied and removed automatically for internal calibration.

Step	Key (or instruction)	Display/Printout
1. Turn on balance/scale, if necessary.		0.0 g
2. Tare the balance/scale, if necessary.		0.0 g
3. Start calibration/adjustment Internal weight is applied automatically.		CAL
4. Balance/scale is calibrated (displayed only if menu code $\uparrow$ 10 $\downarrow$ 2 is set).		- 0.2 g CAL $\pm$ 
5. If the menu code for "calibration and adjustment in a single step" ( $\uparrow$ 10 $\downarrow$ 1) is set, the balance/scale is adjusted automatically now.		Adjust* CAL
6. At this point, adjustment is completed.		CAL
7. Internal weight is unloaded.		0.0 g







\* displayed only if menu item  $\uparrow$  10  $\downarrow$  2 is selected.

## External Calibration

Settings:

Calibration/adjustment mode: External calibration/adjustment (menu code 1 9 1)

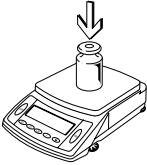
The weight required for calibration/adjustment is defined in the factory settings (see “Specifications”).

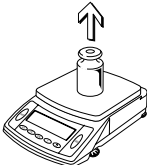
Step	Key (or instruction)	Display/Printout
1. Turn on the balance/scale, if necessary.		0.0 g
2. Tare the balance/scale, if necessary.		0.0 g
3. Start calibration/adjustment.		+5000.0 g CAL 
4. Apply the prompted calibration weight (in this example: 5000 g).		
5. Balance/scale is calibrated (displayed only if menu code 1 10 2 is set).		- 0.2 g CAL ± 
6. If the menu code for “calibration and adjustment in a single step” (1 10 1) is set, the balance/scale is now adjusted automatically.		Adjust* CAL
7. At this point, adjustment is completed.		CC CAL
8. After calibration, the weight unit is shown.		+ 5000.0 g
9. Remove the calibration weight.		0.0 g

\* displayed only if menu item 1 10 2 is selected.



# Configuration

## Purpose



You can configure your balance/scale to meet individual requirements by selecting from parameter settings in a software menu.

## Key functions during configuration:

Activate the settings menu:

Press  to turn the balance/scale off and back on again. While all display segments are lit, press  briefly

Scroll upward ↑: press 



Scroll right →: press  / 

Confirm input: press 

Store settings and exit menu:



Press and hold  (2 sec.)

## ● Print Current Settings

- At the 3rd menu level (lowest level):  
Press and hold  / 

> Printout: (Example)

```
Menu 7 1 1
```



- At the 2nd menu level: Press and hold  / 

> Printout (Example)

```
Menu 7 1 1
```

```
Menu 7 2 1
```



















```
Menu 7 3 1
```

- All current menu settings are printed when the 1st menu level (highest level) is displayed: Press and hold  / 
- > All current settings are printed.



### Setting the Parameters (Menu Codes)

Example: Adapting the balance/scale to “very unstable” ambient conditions (menu code 114).

Step	Key (or instruction)	Display/Printout
1. Turn off the balance/scale.		
2. Turn on the balance/scale and		
while all segments are displayed:	 briefly	1
<input type="radio"/> Scroll upward within a menu level; after the last menu code, the first code is displayed again.	 repeatedly	2 3 4
3. Select the second level (scroll to the right).	 / 	1 1
4. Select the third level (scroll to the right).	 / 	1 1 2 °
5. 3 <sup>rd</sup> menu level: Scroll until the desired number is shown.	 repeatedly	1 1 4
6. Confirm change; “o” on display indicates active setting		1 1 4 °
<input type="radio"/> Return to higher menu level (from the 3 <sup>rd</sup> level).	 / 	1
<input type="radio"/> Set other codes as desired.	 /  , 	
7. Store settings and exit the menu	Press and hold  (2 sec.)	
or		
<input type="radio"/> Exit menu without storing changes.		
> Restart application.		0.0 g

## Parameter Settings (Overview)

o Factory settings

√ User-defined setting

Menu	Menu level 1	Menu level 2	Menu level 3	Factory setting	Menu item
1	Weighing	1 1 Adapt filter (ambient conditions)	1 1 1	Very stable conditions	o Stable conditions Unstable conditions Very unstable conditions
			1 1 2	Stable conditions	
			1 1 3	Unstable conditions	
			1 1 4	Very unstable conditions	
		1 2 Application filter	1 2 1	Final readout	o Final readout Filling mode
			1 2 2	Filling mode	
		1 3 Stability range The stability symbol is displayed when the value is stable within this number of digits.	1 3 1	1/4 digit	o 1 digit 2 digits 4 digits 8 digits*
			1 3 2	1/2 digit	
			1 3 3	1 digit	
			1 3 4	2 digits	
			1 3 5	4 digits	
			1 3 6	8 digits*	
		1 5 Tare function*	1 5 1	Without stability	o After stability
			1 5 2	After stability	
		1 6 Auto zero	1 6 1	On	o On Off
			1 6 2	Off	
		1 7 Weight unit 1	1 7 1	Grams (Display: o)*	o Grams (Display: g) Kilograms 1) Carats Pounds* Ounces* Troy ounces* Hong Kong taels* Singapore taels* Taiwanese taels* Grains* Pennyweights* Milligrams 2) Parts per pound* Chinese taels* Mommies* Austrian carats* Tola* Baht* Mesghal*
			1 7 2	Grams (Display: g)	
			1 7 3	Kilograms 1)	
			1 7 4	Carats	
1 7 5	Pounds*				
1 7 6	Ounces*				
1 7 7	Troy ounces*				
1 7 8	Hong Kong taels*				
1 7 9	Singapore taels*				
1 7 10	Taiwanese taels*				
1 7 11	Grains*				
1 7 12	Pennyweights*				
1 7 13	Milligrams 2)				
1 7 14	Parts per pound*				
1 7 15	Chinese taels*				
1 7 16	Mommies*				
1 7 17	Austrian carats*				
1 7 18	Tola*				
1 7 19	Baht*				
1 7 20	Mesghal*				
1 8	see next page				
2 through 9	see next pages				

\* = Setting cannot be changed on verified balances/scales

1) = Not available in the CP64-0CE

2) = Not available in verified balances/scales of accuracy class  $\text{II}$

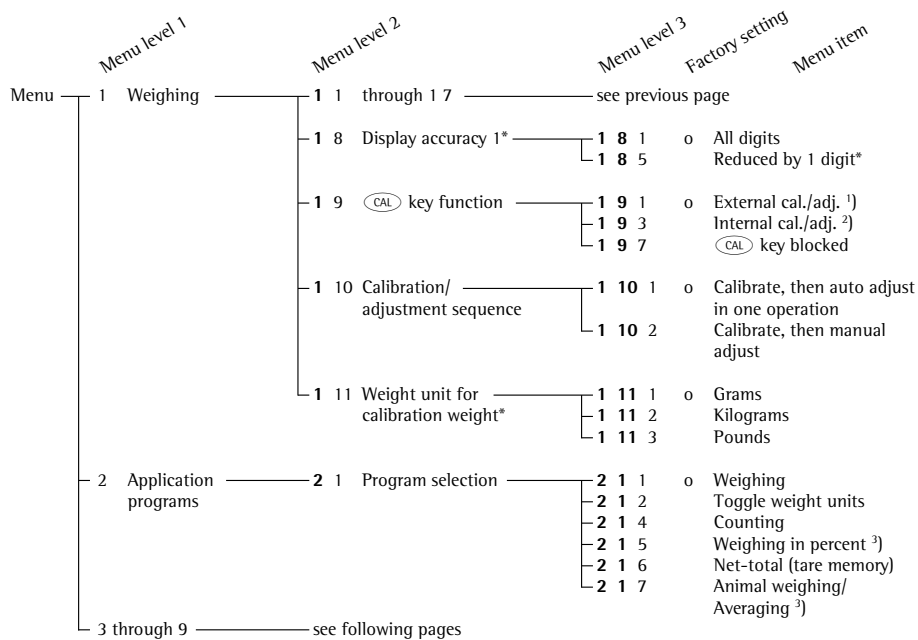

\* = Setting cannot be changed on verified balances/scales

<sup>1)</sup> = Not available in balances/scales of accuracy class 

<sup>2)</sup> = On models with built-in motorized calibration weight only

<sup>3)</sup> = Not available in CP...-ACE/...-PCE models

Menu	Menu level 1	Menu level 2	Menu level 3	Factory setting	Menu item
	1 and 2	see previous pages			
	3	Application parameters			
		3 1	Weight unit 2		
				3 1 1	Grams (Display: o)*
				3 1 2	o Grams (Display: g)
				3 1 3	Kilograms <sup>1)</sup>
				3 1 4	Carats
				3 1 5	Pounds*
				3 1 6	Ounces*
				3 1 7	Troy ounces*
				3 1 8	Hong Kong taels*
				3 1 9	Singapore taels*
				3 1 10	Taiwanese taels*
				3 1 11	Grains*
				3 1 12	Pennyweights*
				3 1 13	Milligrams <sup>2)</sup>
				3 1 14	Parts per pound*
				3 1 15	Chinese taels*
				3 1 16	Mommes*
				3 1 17	Austrian carats*
				3 1 18	Tola*
				3 1 19	Baht*
				3 1 20	Mesghal*
		3 2	Display accuracy 2*		
				3 2 1	o All digits
				3 2 5	Reduced by 1 digit
		3 5	Storage parameter Counting and Weighing in Percent		
				3 5 1	Internal resolution
				3 5 2	o Display accuracy
		3 6	Decimal places for calculations		
				3 6 1	None
				3 6 2	o 1 decimal place
				3 6 3	2 decimal places
				3 6 4	3 decimal places
		3 7	Animal activity		
				3 7 1	Calm
				3 7 2	o Normal
				3 7 3	Active
		3 8	Start Animal weighing		
				3 8 1	Manual start
				3 8 2	o Automatic start
	4	Application parameters – Counting			
		4 1	Autom. reference- sample updating		
				4 1 1	o Off
				4 1 2	On
	5 through 9	see next page			

\* = Setting cannot be changed on verified balances/scales

<sup>1)</sup> = Not available in the CP64-OCE

<sup>2)</sup> = Not available in verified balances/scales of accuracy class **II**

Menu	Menu level 1	Menu level 2	Menu level 3	Factory setting	Menu item	
	1 through 3	see previous page				
5	Data interface	5 1 Baud rate	5 1 1	150 baud		
			5 1 2	300 baud		
			5 1 3	600 baud		
			5 1 4	1,200 baud	o	
			5 1 5	2,400 baud		
			5 1 6	4,800 baud		
			5 1 7	9,600 baud		
			5 1 8	19,200 baud		
		5 2 Parity	5 2 1	Mark		
			5 2 2	Space		
			5 2 3	Odd	o	
			5 2 4	Even		
		5 3 No. of stop bits	5 3 1	1 stop bit	o	
			5 3 2	2 stop bits		
		5 4 Handshake mode	5 4 1	Software		
			5 4 2	Hardware, 2 char. after CTS	o	
			5 4 3	Hardware, 1 char. after CTS		
		5 5 Communications mode	5 5 1	SBI (ASCII)	o	
			5 5 2	Universal printer		
		6	Print for weighing	6 1 Manual/auto print mode	6 1 1	Manual without stability with  /  key
6 1 2	Manual at stability with  /  key				o	
6 1 3	Manual at stability with  /  key					
6 1 4	Automatic without stability					
6 1 5	Automatic at stability					
6 1 6	Automatic when load changed <sup>1)</sup>					
6 2 Stop automatic printing	6 2 1			Manual ( /  key)		
	6 2 2			Not stoppable	o	
6 3 Time-dependent autom. printing	6 3 1			1 display cycle	o	
	6 3 2			2 display cycles		
6 4 Tare the balance/scale after ind. printout	6 4 1			Off	o	
	6 4 2			On		
7 through 9	see next page					

<sup>1)</sup> = Auto print when load change is > 10 d and stability is reached: no printout until residual difference in load value is < 5 d; not available in CP...-ACE/...-PCE models

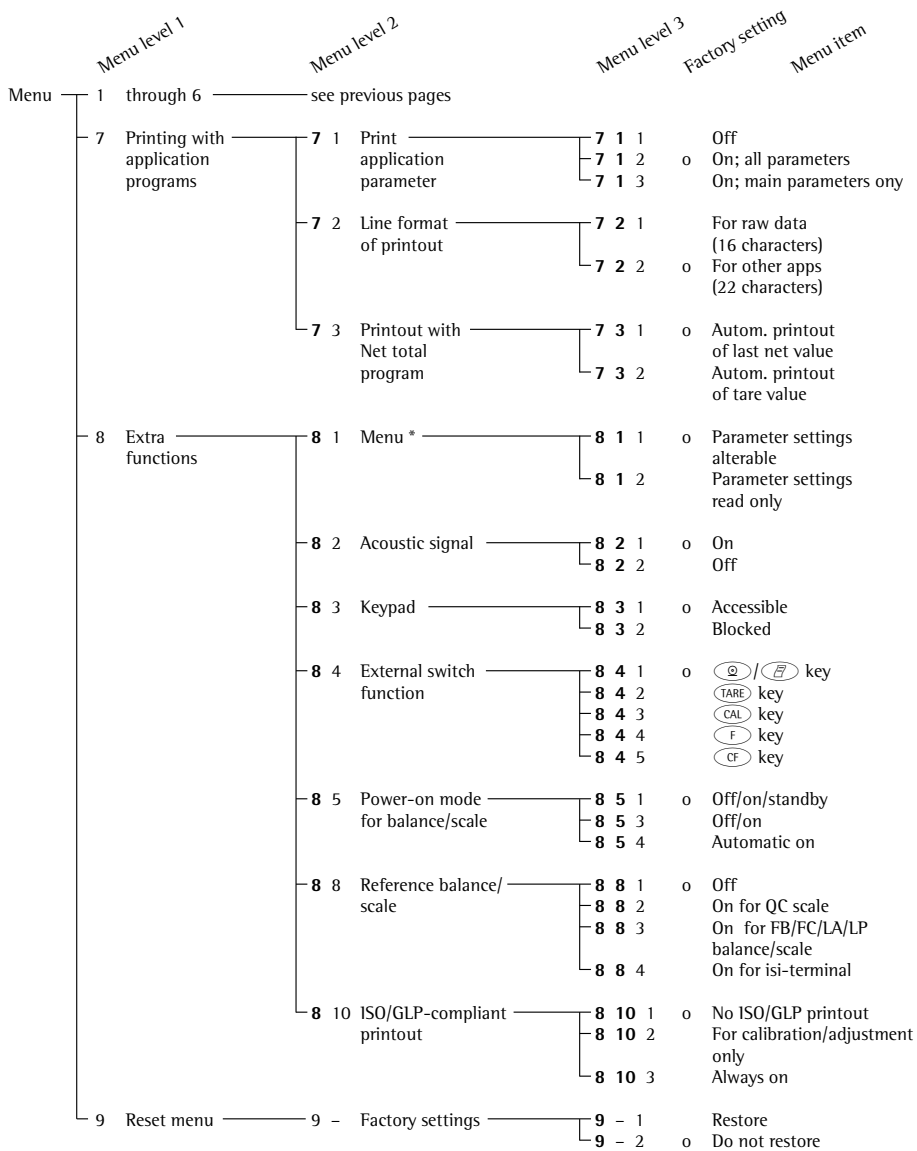

\* = Setting cannot be changed on verified balances/scales

---

# Setting IDs, Time, Date and Display Brightness

## Purpose



Configuring measurement environment parameters for ISO/GLP-compliant data records.

Setting date and time (for ISO/GLP-compliant records only). Adapting display to ambient lighting conditions.



## Features

- Enter up to 8 characters to identify a measurement series. Permissible characters include the numbers 0 through 9, the dash or minus sign (“-”) and spaces. Leading zeroes are output as spaces.
- Date and time of beginning and end of series recorded.
- Display brightness <sup>1)</sup>:  
0 = off, levels of brightness: 1 through 9

## Activate the ID number, date and time configuration menu:

Press  to turn the balance/scale off and back on again. While all display segments are lit, press  briefly

Scroll upward ↑: press 

Scroll right →: press  / 





















Press  to confirm input and toggle between ID number, time and date.

Store settings and exit menu:





Press and hold  (2 sec.)

<sup>1)</sup> No display backlighting on models CP2P..., CP225D and CP225D-0CE

Example: Setting the time, date and display brightness

Step	Key (or instruction)	Display/Printout
1. Turn off the balance/scale.		
2. Turn on the balance/scale and  while all segments are displayed:		
	 briefly	-----
○ Move cursor in 8-character ID.	 /  repeatedly	-----
○ Set or change ID.	 repeatedly	-3-----
3. Confirm ID and activate time.		H 10. 14. 11
4. Select 24-hour clock (“H”) or 12-hour clock, (“P”).		H 10. 14. 19
5. Toggle between hours, minutes and seconds.	 / 	H 10. 15. 19
6. Synchronize seconds with reference clock.		H 10. 15.00
7. Confirm time and activate date.		29.JAN.01
8. Set date “Day”, “Month”, and  if desired, set “Year”. Confirm date and activate display brightness.	 repeatedly,  /   repeatedly,  /   repeatedly	01.JAN.01
		22.APR.01



Step	Key (or instruction)	Display/Printout
9. Set display brightness.	 repeatedly	LAMP 7
10. Store settings and exit the menu  or	Press and hold  (2 sec.)	
○ Exit menu without storing changes.		
> Restart application.		0.0 g

---

# Application Programs

## Function Keys

**F**: Start application program/  
Store component.

**F** Toggle between component  
press and weight and total weight  
hold for (net-total formulation);  
 $\geq 2$  seconds: change reference quantity  
(counting), reference  
percentage (weighing in  
percent) or number of measure-  
ments (animal weighing)

**CF**: End application program; delete

Using Verified Balances/Scales as Legal  
Measuring Instruments in the EU\*:

All application programs can be selected  
on balances/scales used as legal measuring  
instruments. Calculated values can be  
indicated as follows:

- Percent = %
- Piece count (counting) = pcs
- Computed value = 0,  $\Delta$

\* including the Signatories of the Agreement  
on the European Economic Area

---

# Net-Total Formulation

Menu code: 2 1B\*

Display symbol: ↓

## Purpose

With this application program you can weigh in different components up to a defined total. You can also print out the total weight and the individual weights of the components.

## Features

- Tare function
- Weigh up to 99 components from “0” to a defined total component weight
- Store component weights (“Store xx comp.”), with
  - display zeroed automatically after value is stored, and
  - automatic printout (print application parameters); either
    - of the last component weight (net value) or
    - of the total weight (tare value)
- Clear component memory when weighing series is canceled by pressing (CF); total weight printed if “Print all parameters” is selected in the operating menu; otherwise, the normal net weight printout is generated ((O)/(E) key).
- Toggling between component weight and total weight by pressing and holding (F).
- Printout of the total of the individual component weights (T COMP)

\* = Factory setting on CP...-ACE/...-PCE models only

### Preparation

Set parameters for Net-Total Formulation:

- Select the application program in the operating menu
- Set parameters for automatic printout when component stored

2 Application programs

└ 2 ; Program selection

└ 2 ; 6\* Net-total

7 Print for application

└ 7 ; Print application parameters

└ 7 ; ; Off

└ 7 ; 2 o On; all parameters

└ 7 ; 3 On; only main parameters

└ 7 3 Printout of net-total formulation data

└ 7 3 ; o Autom. print of last net value

└ 7 3 2 Autom. print of tare value

o = Factory setting

\* = Factory setting on CP...-ACE/...-PCE models only

### Printout of Net-total Formulation Data

Comp2	+	278.1	g :
T COMP+		2117.5	g :
T1	+	1821.5	g :
N1	+	278.1	g :
N	+	2099.6	g :

Second component

Sum of components

Tare weight (2nd tare memory)







Net weight = Gross - Tare -

2nd Tare memory

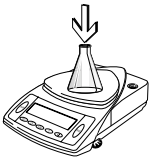
Net weight = Gross - Tare

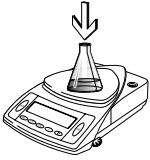
**Example:** Weighing-in several components

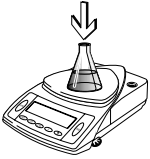
Settings: Application program: Net-total formulation 2 / 5;  
 Print application parameters: On, print all 7 / 2; Line format for printout:  
 22 characters 7 2 2; Automatic printout of last net value 7 3 /

Step	Key (or instruction)	Display/Printout
1. Turn on the balance/scale, if necessary		
2. Place empty container on the balance/scale.		+ 65.0 g
3. Tare the balance/scale.		0.0 g
4. Add first component.		+ 120.5 g
5. Store component data.		0.0 g <sub>NET</sub> COMP1 + 120.5 g
6. Add next component.		+ 70.5 g
7. Store component data.		0.0 g <sub>NET</sub> COMP2 + 70.5 g
8. Weigh in further components if desired.	Repeat steps 5 and 6.	
9. Fill to target if desired.	Press and hold  (2 sec.)	+ 191.0 g G

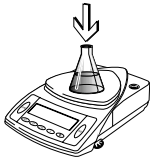
Step	Key (or instruction)	Display/Printout
10. Add last component.		+ 12.5 g G
11. Store component data.	F	0.0 g <sub>NET</sub> COMP 3+ 12.5 g
12. Display total weight.	CF	+ 203.5 g T COMP+ 203.5 g

---

# Counting

Menu code: 2 14

Display symbol: ❖

## Purpose

With the Counting program you can determine the number of parts that each have approximately equal weight.

## Features

- The minimum load is equal to one digit, defined according to the resolution of the active weight unit.
- Press and hold the (F) key (2 seconds) to set the reference sample quantity.
- Configure the resolution used when reference sample quantity is stored and piece counts are calculated.
- Optional automatic output of the piece count and average piece weight to the data interface port when the menu code 7 12 (print application parameters) is set.
- Long-term storage of the last reference sample quantity "nRef" entered.
- Toggling between piece count and weight by pressing (F).

## Function Keys

(F):

Begin determination of piece weight

- > Application program initialized with predefined reference sample quantity.

(CF):

End application program; clear initialization data

Changing the reference sample quantity:

- Press and hold (F) (2 sec.)
- > Current reference sample quantity is displayed.
- Press (F) briefly to change the value; press repeatedly until the desired reference sample quantity is displayed. Quantities to choose from: 1, 2, 5, 10, 20, 50, 100.
- Store setting in long-term memory: Press and hold (F).

---

### Reference Sample Updating

Automatic reference sample updating optimizes the counting accuracy. You can activate or de-activate this function in the menu.

Automatic reference sample updating is performed when:

- the criterion for the stability parameter selected in the menu has been met
- the current piece count is less than twice the original piece count
- the current piece count is less than  $100 \times$  the initialization value
- the internally calculated piece count (such as 17.24 pcs) differs by less than  $\pm 0.3$  pcs from the whole number (17 pcs in this example)
- > The abbreviation  $\sigma P E$ , for “optimizing”, is displayed briefly with the new reference sample quantity.

### Reference Weighing

(Counting with two balances/scales)

Purpose:

Use of a reference balance/scale affords higher precision in counting large amounts of parts. The CP balance is used to determine the reference weight. The following Sartorius terminals can be used for sample weighing in conjunction with a reference balance/scale:

- For QC scales menu code  $B B 2$
- For FB/FC/LA/LP series balances/scales, menu code  $B B 3$
- For isi terminals menu code  $B B 4$
- Please order the required connecting cables directly from Sartorius

The following settings must have the same configurations in both balances/scales:

- “Counting” program
- Weight units
- Settings in the CP balance:
  - Set menu codes  $7 1 2$  and  $7 2 2$
- All data interface parameters
  - Baud rate
  - Parity
  - Number of stop bits
  - Handshake mode

Transfer Function in the CP Balance:

- Press the  $\textcircled{F}$  key
- > The reference value is transferred to the counting balance/scale

Counting Balance/Scale:

- See the operating instructions of the balance/scale in question for details



### Preparation

Set parameters for the “Counting” program:

- Select the application program in the operating menu

- Set the following parameters:

2 Application programs  
└─ 2 1 Program selection  
    └─ 2 1 4 Counting

3 Application parameters  
└─ 3 5 Storage parameter  
    └─ 3 5 1 Internal resolution  
    └─ 3 5 2 o Display accuracy

4 Application parameters for Counting  
└─ 4 1 Autom. ref. sample updating  
    └─ 4 1 1 o Off  
    └─ 4 1 2 On

8 Extra functions  
└─ 8 8 Reference balance/scale  
    └─ 8 8 1 o Off  
    └─ 8 8 2 On for QC scales  
    └─ 8 8 3 On for FB-/FC-/LA-/LP models  
    └─ 8 8 4 On for isi terminals

o = Factory setting

### Printout: Counting

nRef	+	10	:
wRef	+	21.14 g	:
Qnt	+	500 pcs	:

Reference sample quantity  
Reference weight  
Calculated quantity









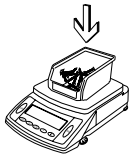

**Example:** Counting pieces of equal weight

Settings:

Menu: Counting program (menu code 2 1 4),

Print application parameters: On; all parameters (menu code 7 1 2),

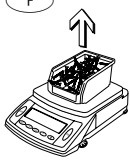
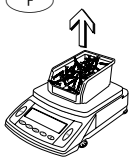
Line format for printout: 22 characters (menu code 7 2 2)

Step	Key (or instruction)	Display/Printout
1. Turn on the balance/scale, if necessary.		
2. Place empty container on the balance/scale.		+ 22.6 g
3. Tare the balance/scale.		0.0 g
4. Add reference sample quantity to container (in this example: 10 pcs).		
5. Initialize the balance/scale.		rEF 10 (briefly) + 2.14 g + 10 pcs nRef + 10 pcs wRef + 2.14 g
6. Add desired number of pieces.		+ 500 pcs
7. Print piece count, if desired.	 / 	Qnt + 500 pcs
8. Display weight.		+ 1070.0 g
9. Display piece count.		+ 500 pcs
10. Unload the balance/scale.		- 511 pcs
11. Repeat as necessary, starting from step 6.		
12. Delete reference sample quantity.		0.0 g

# Weighing in Percent

Menu code: 2 15\*

Display symbol: %

## Purpose

This application program allows you to obtain weight readouts in percent which are in proportion to a reference weight.

## Features

- The minimum load is equal to one digit, defined according to the resolution of the active weight unit.
- Press and hold the (F) key (2 seconds) to set the reference percentage
- Storage parameter (rounding-off factor) for storing the reference weight to calculate the percentage can be configured.
- Configuration of decimal places displayed with a percentage.
- Optional automatic output of the reference weight "Wxx%" and reference percentage to the data interface port when the menu code 7 12 (print application parameters) is set.

- Long-term storage of the last reference percentage "pRef" entered.
- Toggling between percentage and weight by pressing (F).

## Function Keys

(F):  
Begin calculation of percentage

- > Current weight value stored as reference weight "Wxx%" to be loaded at initialization.

(CF):  
End application program;  
clear initialization data

Changing the reference percentage:

- Press and hold (F) (2 sec.)
- > Current reference percentage is displayed.
- Press (F) briefly to change the value; press repeatedly until the desired reference percentage is displayed.  
Quantities to choose from: 1, 2, 5, 10, 20, 50, 100.
- Store setting in long-term memory:  
Press and hold (F).

\* = not available in CP...-ACE/...-PCE models

### Preparation

Set parameters for the “Weighing in Percent” program:

- Select the application program in the operating menu
- Set the following parameters:

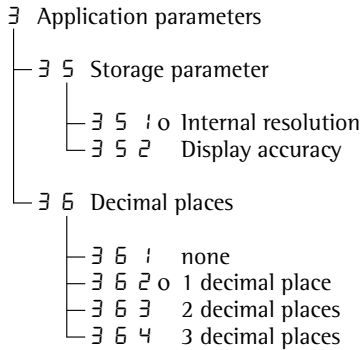
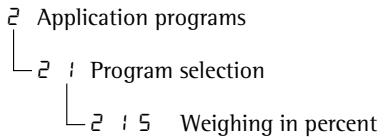

o = Factory setting

### Printout: Weighing in Percent

pRef	+	100	%:
Wxx%	+	111.6	g:
Prc	+	94.7	%:

Reference percentage  
Reference weight net xx%  
Calculated reference percentage

**Example:** Determining residual weight in percent







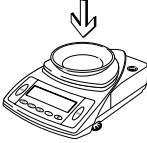

Settings:

Menu: Weighing in percent program (menu code 2 1 5),

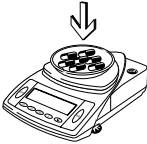
Print application parameters: On; all parameters (menu code 7 1 2),

Line format for printout: 22 characters (menu code 7 2 2)

Reference percentage: REF 100%

Step	Key (or instruction)	Display/Printout
1. Turn on the balance/scale, if necessary.		
2. Place empty container on balance/scale.		+ 22.6 g
3. Tare the balance/scale.		0.0 g
4. Place sample equal to 100% of reference percentage on the balance/scale (in this example: 111.6 g).		
5. Initialize the balance/scale.		REF 100 (displayed briefly) + 111.6 g + 100.0 % pRef + 100 % Wxx% + 111.6 g
6. Remove container; for example, to treat sample (in this example, the sample is now dried).		
7. Place container with sample on the balance/scale again (after treatment).		+ 94.9 %
8. Optional: print percentage.	 / 	Pr c + 94.9 %
9. Display residual weight and delete reference value.		+ 105.9 g
10. Optional: print net residual weight.	 / 	N + 105.9 g

# Animal Weighing/Averaging

Menu code: 2 17\*



Display symbol: 

## Purpose

Use this program to determine the weights of unstable samples (e.g., live animals) or to determine weights under unstable ambient conditions. With this program, the balance/scale calculates the weight as the average of a defined number of individual weighing operations (also referred to as “subweighing operations”).

## Features

- Animal weighing started manually or automatically
- Minimum load threshold for starting animal weighing:
  - for automatic start: 100 display intervals
  - for manual start: 50 display intervals
- Automatic start:  
Begin the averaging operation by pressing **F**. “**AUTO**” is displayed during weighing to indicate that the following values will be averaged automatically.  
Animal activity: Averaging begins automatically once two subweights are measured within a predefined tolerance range (calm = 2%, normal = 5%, active = 20%).
- Number of weighing operations for calculation of an average **m D e f** can be set before the beginning of each series.

- Number of remaining weighing operations in the current series is shown during weighing.
- Arithmetic average displayed as a result in the pre-set weight unit (identified by the ). The  symbol flashes during this time.
- Toggling between weighed and calculated results by pressing **F** (after initialization)
- Unload threshold is one-half of the minimum load.
- Balance/scale returns to the basic weighing mode when unloaded; i.e., when the load is below the unload threshold

## Function Keys

**F**:  
Activate animal weighing program

**CF**:  
End application program; delete result; interrupt measuring operation.

Changing the number of subweighing operations:

- Press and hold **F** (2 sec.)  
> Current number of subweighing operations is displayed.
- Press **F** briefly to change the value; press repeatedly until the desired number is displayed.  
Quantities to choose from: 5, 10, 20, 50, 100.
- Store setting in long-term memory:  
Press and hold **F**.

\* = not available in CP...-ACE/...-PCE models

### Preparation

Set parameters for the “Animal Weighing” program:

- Select the application program in the operating menu
- Set the following parameters:

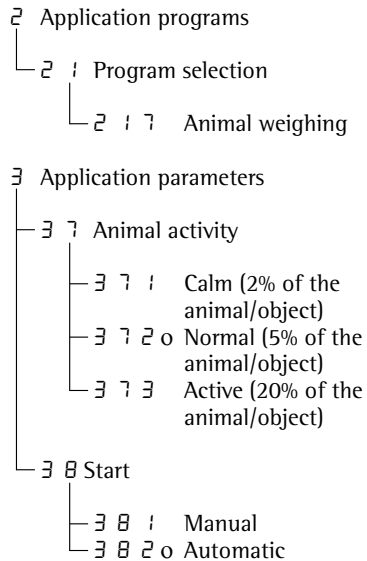

o = Factory setting

### Printout: Animal Weighing

```
mDef          20 :
x-Net +      401.1 g:
```

Number of subweighing operations  
Calculated average





**Example:** Determining animal weight with automatic start of 20 subweighing operations

Settings:

Menu: Animal weighing program (menu code 2 1 7),

Print application parameters: On; all parameters (menu code 7 1 2),

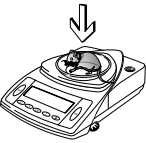
Line format for printout: 22 characters (menu code 7 2 2)

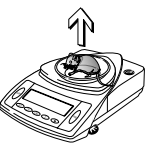
Step	Key (or instruction)	Display/Printout
1. Turn on the balance/scale, if necessary.		
2. Place animal weighing bowl on the balance.		+ 22.6 g
3. Tare the balance/scale.		0.0 g
4. Place 1st animal in bowl.		Weight value fluctuates due to animal activity.
5. Start automatic animal weighing. The balance/scale delays starting the subweighing operation until successive subweights lie within the range defined.		<pre> 888 20 19 18   ;           </pre>
6. After 20 subweighing operations the arithmetic average "x-Net" is displayed.		<pre> + 410.1 g Δ mDef          20 x-Net +      410.1 g           </pre>
7. Unload the balance/scale.		0.0 g
8. Weigh next animal (if applicable)		
Next weighing series begins automatically		



# Toggle between Weight Units

Menu code: 2 12

## Purpose

With this application program you can switch the display of a weight value back and forth between two weight units.

Configure the “Toggle Weight Units” application in the operating menu:  
See “Configuration,” menu code 2 12: Toggle weight units  
(factory setting in GC and GP scales)

Menu code Weight unit 1	Weight unit 2	Unit	Conversion	Display	Printout
1 7 1	3 1 10	Grams * 1)	1.0000000000	o	o
1 7 20	3 1 20	Grams 2)	1.0000000000	g	g
1 7 3	3 1 3	Kilograms 3)	0.0010000000	kg	kg
1 7 40	3 1 4	Carats	5.0000000000	ct	ct
1 7 5	3 1 5	Pounds*	0.00220462260	lb	lb
1 7 6	3 1 6	Ounces*	0.03527396200	oz	oz
1 7 7	3 1 7	Troy ounces*	0.03215074700	ozt	ozt
1 7 8	3 1 8	Hong Kong taels*	0.02671725000	tl	tlh
1 7 9	3 1 9	Singapore taels*	0.02645544638	tl	tls
1 7 10	3 1 10	Taiwanese taels*	0.02666666000	tl	tlt
1 7 11	3 1 11	Grain*	15.4323583500	GN	GN
1 7 12	3 1 12	Pennyweights*	0.64301493100	dwt	dwt
1 7 13	3 1 130	Milligrams 4)	1000.00000000	mg	mg
1 7 14	3 1 14	Parts per pounds*	1.12876677120	o	/lb
1 7 15	3 1 15	Chinese taels*	0.02645547175	tl	tlc
1 7 16	3 1 16	Mommes*	0.26670000000	m	mom
1 7 17	3 1 17	Austrian carats*	5.00000000000	K	K
1 7 18	3 1 18	Tola*	0.08573333810	t	tol
1 7 19	3 1 19	Baht*	0.06578947437	b	bat
1 7 20	3 1 20	Mesghal*	0.21700000000	m	MS

o = Factory setting, depends on model

\* = Not available in verified balances/scales

1) = GP3202: readability with Taiwanese taels reduced by one decimal place

2) = GC1603P, GC 803P/S: readability 0.0002 g; GC2502: readability 0.001 g

3) = Not available in the CP64-0CE

4) = Not available in verified balances/scales of accuracy class  $\text{E}_2$

## Function

- Press  $\text{F}$  to toggle between weight unit 1 and weight unit 2.

---

# Generating a Printout

## Purpose

You can generate a printout of weights as well as other measured values and identification codes for documentation purposes. You can format the printout to meet individual requirements.



## Features

Printouts generated automatically or manually (at the press of a key): weight or calculated value is output.

Line format: Each value printed with up to 6 preceding characters for identification

Print application parameters:  
Printout of initialization values before printing measurement results.

ISO/GLP-compliant printout:  
Printout of ambient characteristics.

Printouts generated automatically or by pressing  / , dependent on or independent of stability

You can have the following values output automatically when using the application programs if menu code  $\overline{7} \overline{1} \overline{2}$  is configured (printout with data ID codes):

- Net-total: Component or total weight
- Counting:  
Reference sample quantity (nRef)  
Reference weight for one piece (average piece weight; wRef)
- Weighing in percent:  
Reference percentage (pRef)  
Reference weight (Wxx%)
- Animal weighing/averaging:  
Number of subweighing operations (mDef)  
Calculated average (x-Net)

---

### Factory Settings

Print manual/automatic: Individual printout dependent on stability:  
Manual at stability (menu code 5 1 2)

Line format:

Up to 6 characters at the beginning of each line to identify the weight or calculated value: Print net, tare, or gross value, reference sample quantity, or average piece weight with ID (menu code 7 2 2).

Print application parameters:



Printout of one or more initialization values for the active application program:  
On (menu code 7 1 2)

ISO/GLP-compliant printout:

No ISO/GLP-compliant printout (menu code 8 1 1)

Auto print:

Automatic printout of weight values:  
No default setting; see print manual/automatic (menu code 5 1 2)

Automatic printout after each display cycle (menu code 5 3 1), cannot be interrupted by pressing / (menu code 5 2 2)

- Set the following parameters:  
See “Configuration”

Printout without Data ID Codes:

The value currently displayed is printed (weight or calculated value with unit)

	+	1530.0	g
	+	58.562	oz t
	+	253	pcs
	+	88.2	%

Weight in grams  
Weight in Troy ounces  
Piece count  
Percentage

Printout with Data ID Codes:

The current value displayed can be printed with a data ID code of up to 6 characters at the beginning of the line.

ID		12345678	
N	+	153.0	g
T1	+	23.4	g
Qnt	+	253	pcs
Prc	+	88.23	%

Identification\*  
Current net weight  
Value in 2nd tare memory  
Piece count  
Percentage  
\* = on ISO/GLP records only

Print Application Parameters:

You can generate a printout of one or more of the values configured for initialization of an application as soon as you initialize the balance/scale.

Comp7	+	278.1	g
T COMP	+	21.14	g
nRef	+	10	
wRef	+	21.14	g
Wxx%	+	1200.0	g

Net-total: 7<sup>th</sup> component weight  
Net-total: Total  
Counting: Reference sample quantity  
Counting: Reference weight  
Weighing in percent:  
Reference weight

Auto Print:

You can have the weight readout printed automatically.

N	+	153.0	g
Stat			
Stat		L	
Stat		H	

Net weight  
Display blank  
Display underload  
Display overload

# ISO/GLP-compliant Printout/Record

## Features

You can have the parameters pertaining to the ambient weighing conditions printed before (GLP header) and after (GLP footer) the values of a weighing series. These parameters include:

GLP header:

- Date
- Time at beginning of measurement
- Balance/scale manufacturer
- Balance/scale model
- Balance/scale serial number
- Software version number
- Identification number of the current sampling operation

GLP footer:

- Date
- Time at end of measurement
- Field for operator signature

The record is output to a Sartorius data printer or a computer.

## Settings

- Set the following menu codes (see "Configuration"):
  - ISO/GLP-compliant record after calibration/adjustment only: menu code  $\text{B } \text{I} \text{D } \text{2}$ ; or ISO/GLP-compliant record always on: menu code  $\text{B } \text{I} \text{D } \text{3}$
  - Line format for printout: With data ID codes
    - 22 characters: menu code  $\text{7 } \text{2 } \text{2}$

△ No ISO/GLP-compliant record is output if any of the following settings are configured: menu codes  $\text{6 } \text{1 } \text{4}$ ,  $\text{6 } \text{1 } \text{5}$ ,  $\text{6 } \text{1 } \text{6}$  (automatic printout) and  $\text{7 } \text{2 } \text{1}$

## Function Keys

Press  $\text{Q}$  /  $\text{H}$  to output header and first measured value.

- > Header is output the first time  $\text{Q}$  /  $\text{H}$  is pressed

To output header and reference data automatically with an application program active: Press  $\text{F}$

End an application:

- 1) Output GLP footer: Press  $\text{CF}$
- 2) End application program: Press  $\text{CF}$

The ISO/GLP-compliant record can contain the following lines:

-----				Dotted line
17-Jan-2001		10:15		Date/time (beginning of measurement)
	SARTORIUS		AG	Balance/scale manufacturer
Mod.		CP8201		Balance/scale model
Ser. no.		10105355		Balance/scale serial number
Ver. no.		00-13-01		Software version
ID		2690	923	ID
-----				Dotted line
L ID				Measurement series no.
nRef	+	10	pcs	Counting: Reference sample quantity
wRef	+	21.14	g	Counting: Reference weight
Qnt	+	235	pcs	Counting result
Qnt	+	567	pcs	Counting result
-----				Dotted line
17-Jan-2001		10:20		Date/time (end of measurement)
Name:				Field for operator signature
				Blank line
-----				Dotted line

ISO/GLP-compliant printout for external calibration/adjustment:

-----					Dotted line
17-Jan-2001		10:30			Date/time (beginning of measurement)
	SARTORIUS		AG		Balance/scale manufacturer
Mod.		CP8201			Balance/scale model
Ser. no.		10105355			Balance/scale serial number
Ver. no.		00-13-01			Software version
ID		2690	923		ID
-----					Dotted line
Cal. Ext.					Calibration/adjustment mode
Set	+	5000.0	g		Calibration weight
Diff.	+	0.2	g		Difference after calibration
Cal. Ext. Complete					Confirmation of completed calibration
Diff.	+	0.0	g		Difference from nominal value after calibration
-----					Dotted line
17-Jan-2001		10:32			Date/time (end of measurement)
Name:					Field for operator signature
					Blank line
-----					Dotted line

---

# Data Interface

## Purpose

Your balance/scale is equipped with an interface port for connection to a computer or other peripheral device. You can use an on-line computer to change, start and/or monitor the functions of the balance/scale and the application programs.

## Features

Type of interface: Serial interface

Operating mode: Full duplex

Standard: RS-232

Transmission rates:

150; 300; 600; 1,200; 2,400; 4,800;

9,600; 19,200 baud

Parity: Mark, space, odd, even

Character format:

1 start bit, 7-bit ASCII, parity,

1 or 2 stop bits

Handshake:

2-wire interface:

via software (XON/XOFF);

4-wire interface: via hardware handshake

lines (CTS/DTR)

Operating mode: SBI

Data output format of the balance/scale:

16 or 22 characters

Factory settings:

Transmission rate: 1,200 baud (5 1 4)

Parity: Odd (5 2 3)

Stop bits: 1 stop bit (5 3 1)

Handshake: Hardware, 2 characters  
after CTS (5 4 2)

Operating mode: Standard SBI (5 5 1)

Print manually/automatically:

Manual at stability (5 1 2)

Preparation

- see "Pin Assignments" and  
"Pin Assignment Chart"

## Identification of Non-Verified Digits

Non-verified digits when "e#d" are automatically marked on the printout by square brackets when you select universal printer: code 5 5 2.

## Output Format with 16 Characters

Display segments that are not activated are output as spaces.

The following characters can be output, depending on the characters displayed on the balance/scale:

### Normal Operation

Position	1	2	3	4	5	6	7	8	9	10	11	12	13	14	15	16
	+				D	D	D	D	D	D	*	U	U	U	CR	LF
or	-	.	.	.	.	.	.	.	.	.		*	*	*		
or	*	*	*	*	*	*	*	*	*	*						

\*: Space  
 D: Digit or letter  
 U: Unit symbol  
 CR: Carriage return  
 LF: Line feed

### Special Codes

Position	1	2	3	4	5	6	7	8	9	10	11	12	13	14	15	16
					*	*	*	*	*	*	*	*	*	*	CR	LF
or							H	*								
or							L	*								
or							C	*								

\*: Space  
 C: Calibration/adjustment  
 H: Overload  
 L: Underload

### Error Codes

Position	1	2	3	4	5	6	7	8	9	10	11	12	13	14	15	16
				E	r	r	*	#	#	#	*	*	*	*	CR	LF

\*: Space  
 # # #: Error code number



Data output example: + 123.56 g

Position	1	2	3	4	5	6	7	8	9	0	1	2	3	4		
	+				1	2	3	.	5	6		g			CR	LF
	+			1	2	3	.	5	[	6	]	g			CR	LF

- Position 1: Plus or minus sign or space
- Position 2: Space
- Positions 3–10: Weight with a decimal point; leading zeros = space
- Position 11: Space
- Positions 12–14: Unit symbol or space
- Position 15: Carriage return
- Position 16: Line feed

#### Data Output with an ID Code (22 Characters)

When data is output with an ID code, the ID code (consisting of 6 characters) precedes the data with the 16-character format. These 6 characters identify the following value.

1	2	3	4	5	6	7	8	9	10	11	12	13	14	15	16	17	18	19	20	21	22
1	1	1	1	1	1	+	*	D	D	D	D	D	D	D	D	*	U	U	U	CR	LF
	*	*	*	*	*	-	.	.	.	.	.	.	.	.	.		*	*	*		
						*	*	*	*	*	*	*	*	*	*						

- I: ID code character
- \*: Space
- D: Digit or letter
- U: Unit symbol <sup>1)</sup>
- CR: Carriage return
- LF: Line feed

Example:

1	2	3	4	5	6	7	8	9	0	1	2	3	4	5	6	7	8	9	0		
N						+				1	2	3	.	5	6		g			CR	LF
N						+				1	2	3	.	5	[	6	]	g		CR	LF

<sup>1)</sup> depends on balance/scale type; e.g., not all units and characters are available on balances verified for use in legal metrology

## Special Codes

1	2	3	4	5	6	7	8	9	10	11	12	13	14	15	16	17	18	19	20	21	22		
S	t	a	t	*	*	*	*	*	*	*	*	*	*	*	*	*	*	*	*	*	CR	LF	
												H	*										
												L	*										

\*: Space

H: Overload

L: Underload

## Error Codes

1	2	3	4	5	6	7	8	9	10	11	12	13	14	15	16	17	18	19	20	21	22
S	t	a	t	*	*	*	*	*	E	r	r	*	#	#	#	*	*	*	*	CR	LF

\*: Space

###: Error number

ID code characters	Meaning
<b>S t a t</b>	Status
<b>T 1</b>	Tare T1
<b>N</b>	Net N
<b>N 1</b>	Net N1
<b>COMPxx</b>	Net-total: Component no.
<b>T COMP</b>	Net-total: Total weighed in
<b>Q n t</b>	Counting: Quantity
<b>w R e f</b>	Counting: Reference weight
<b>n R e f</b>	Counting: Reference sample quantity
<b>P r c</b>	Weighing in percent: Reference percentage
<b>W x x %</b>	Weighing in percent: Reference weight
<b>p R e f</b>	Weighing in percent: Reference percentage
<b>m D e f</b>	Animal weighing: No. of measurements remaining
<b>x - N e t</b>	Animal weighing: Calculated average

## Data Input Format



You can connect a computer to your balance/scale to send commands via the balance/scale interface port to control balance/scale functions and applications.



The commands sent are control commands and may have different formats. Control commands consist of up to 4 characters. Each character must be transmitted according to the settings configured in the operating menu for data transmission.

### Format for Control Commands

Format 1:	Esc	!	CR	LF		
Format 2:	Esc	!	#	_	CR	LF

Esc:	Escape	CR:	Carriage return (optional)
!:	Command character	LF:	Line feed (optional)

Command character	Format 1:
!	Meaning
K	Weighing mode 1 (very stable conditions)
L	Weighing mode 2 (stable conditions)
M	Weighing mode 3 (unstable conditions)
N	Weighing mode 4 (very unstable conditions)
O	Block keys
P	 /  key (print, auto print; activate or block)
R	Release keys
S	Restart/Self-test
T	 key
Z	Internal calibration/adjustment*

Command character	Format 2:
!#	Meaning
f0	Function key 
f1	Function key 
s3	 key
x0	Perform internal calibration*
x1	Print balance/scale model
x2	Print weighing cell serial number

\* = for models with built-in motorized calibration weight only

---

## Synchronization

During data communication between the balance/scale and an on-line device (computer), messages consisting of ASCII characters are transmitted via the interface. For error-free data communication, the parameters for baud rate, parity, handshake mode and character format must be the same for both units.

You can set these parameters in the Setup menu so that they match those of the on-line device. You can also define parameters in the balance/scale to make data output dependent on various conditions. The conditions that can be configured are described under each of the application program descriptions.

If you do not plug a peripheral device into the balance/scale interface port, this will not generate an error message.

## Handshake

The balance/scale interface (Sartorius Balance Interface = SBI) has transmit and receive buffers. You can define the handshake parameter in the Setup menu:

- Hardware handshake (CTS/DTR)
- Software handshake (XON, XOFF)

### Hardware Handshake



With a 4-wire interface, 1 more character can be transmitted after CTS (Clear to Send).

---

### Software Handshake

The software handshake is controlled via XON and XOFF. When a device is switched on, XON must be transmitted to enable any connected device to communicate.



### Data Output by Print Command

The print command can be transmitted by pressing  /  or by a software command (Esc P).

### Automatic Data Output

In the “auto print” operating mode, data is output to the interface port without a print command. You can choose to have data output automatically at defined print intervals with or without the stability parameter. Whichever parameter you select, the data will be output as the readouts appear on the balance/scale display. The display update frequency depends on the settings for “Adapting the filter” (1 1 x) and “Time-dependent automatic printing” (6 3 x).

If you select the auto print setting, data will be transmitted immediately the moment you turn on the balance/scale.

In the operating menu, you can define whether automatic printing can be stopped by pressing  / .

### Faster Output Speeds

If you require output speeds faster than 10 Hz, please contact Sartorius for information.

# Pin Assignment Chart

## Female interface connector:

25-contact D-Submini DB25S with screw-lock hardware

## Male connector used (please use connectors with the same specifications):

25-pin D-Submini DB25 with integrated shielded cable clamp assembly (Amp 826 985-1C) and fastening screws (Amp type 164868-1)

### ⚠ Warning When Using Pre-wired RS-232 Connecting Cables:

RS-232 cables purchased from other manufacturers often have incorrect pin assignments for use with Sartorius balances/scales. Be sure to check the pin assignment against the chart below before connecting the cable, and disconnect any lines marked "Internally Connected" (e.g., pin 6). Failure to do so may damage or even completely ruin your balance/scale and/or peripheral device.

### Pin Assignment Chart:

Pin 1:	Shield
Pin 2:	Data output (TxD)
Pin 3:	Data input (RxD)
Pin 4:	Internal ground (GND)
Pin 5:	Clear to send (CTS)
Pin 6:	Internally connected
Pin 7:	Internal ground (GND)
Pin 8:	Internal ground (GND)
Pin 9:	Reset _ In *)
Pin 10:	Not connected
Pin 11:	+12 V
Pin 12:	Reset _ Out *)
Pin 13:	+ 5 V
Pin 14:	Internal ground (GND)
Pin 15:	Universal remote switch
Pin 16:	Not connected
Pin 17:	Not connected
Pin 18:	Not connected
Pin 19:	Not connected
Pin 20:	Data terminal ready (DTR)
Pin 21:	Ground input for external supply voltage
Pin 22:	Not connected
Pin 23:	Not connected
Pin 24:	Ext. supply voltage input + 12 ... 30 V
Pin 25:	+ 5 V

\*) = Hardware restart

# Cabling Diagram

- For connecting a computer or other peripheral device to the balance/scale using the RS-232-C/V24 protocol and cables up to 15 m (50 ft.) long.

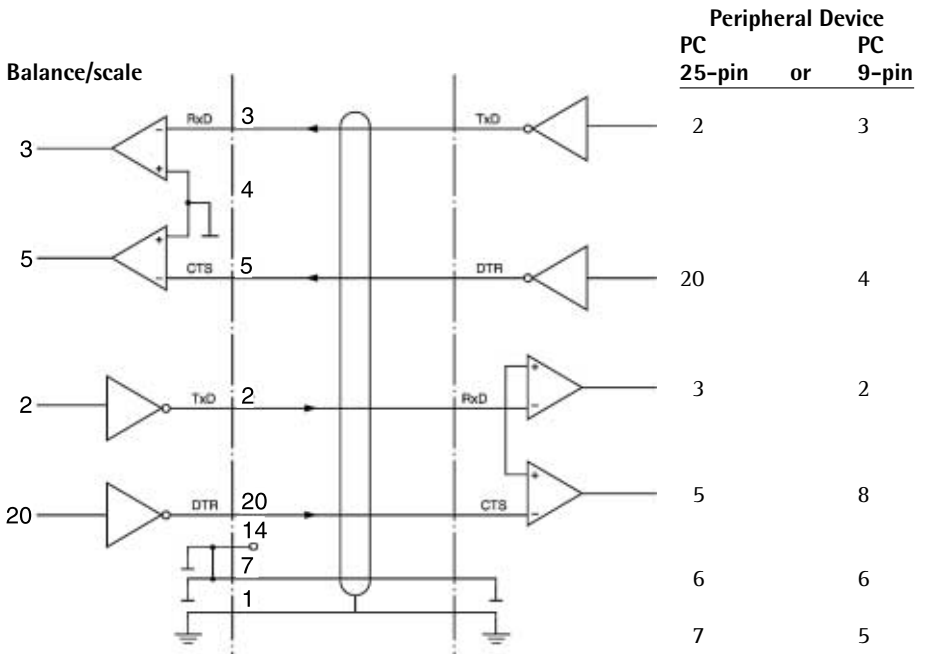
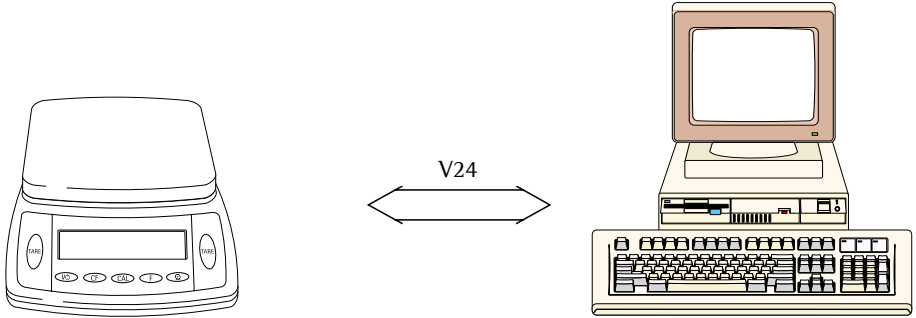

Type of cable: AWG 24 specification

# Error Codes

Error codes are shown on the main display for 2 seconds. The program then returns automatically to the previous mode (e.g., weighing).

Display	Cause	Solution
No segments appear on the display	No AC power is available The AC adapter is not plugged in	Check the AC power supply Plug in the AC adapter
H	The load exceeds the balance/scale capacity	Unload the balance/scale
L or Err 54	Something is touching the load plate/weighing pan	Move the object that is touching the load plate/wp
Err 01	Data output not compatible with output format	Change the configuration in the operating menu
Err 02	Calibration parameter not met; e.g.: – balance/scale not zeroed  – balance/scale is loaded	Calibrate only when zero is displayed Press <b>TARE</b> to zero the balance/scale Unload the balance/scale
Err 10	The <b>TARE</b> key is blocked when there is data in the second tare memory (net-total) – only 1 tare function can be used at a time	Press <b>CF</b> to clear the tare memory and release the tare key
Err 11	Tare memory not allowed	Press <b>TARE</b>
Err 22	Weight is too light or there is no sample on the balance/scale	Increase the weight on the balance/scale
Err 30	Interface port for printer output is blocked	Reset the menu (restore factory settings) or Contact your local Sartorius Service Center



Display	Cause	Solution
Err 235 on the CP225D	Connecting cable not connected correctly Connection to junction on a different balance/scale	Connect the cable correctly Connect the equipment correctly
The weight readout changes constantly	Unstable ambient conditions A foreign object is caught between the load plate and the balance/scale frame	Set up the balance/scale in another area Remove the foreign object
The weight readout is obviously wrong	The balance/scale has not been calibrated/adjusted The balance/scale was not zeroed before weighing	Calibrate/adjust the balance/scale Tare or zero the balance/scale before weighing

**If any other errors occur, contact your local Sartorius Service Center!**

**Contact information:** Please point your Internet browser to: [www.sartorius.com](http://www.sartorius.com)

## Preparing CP2P.. Models for Transport

Model CP2P:

- Remove the weighing pan
- Remove the interior draft shield from the chamber:  
Use your fingers to raise the draft shield carefully until it is free
- Place these parts in the accessory kit
- Fasten the chamber doors by placing a rubber band around the door handles.

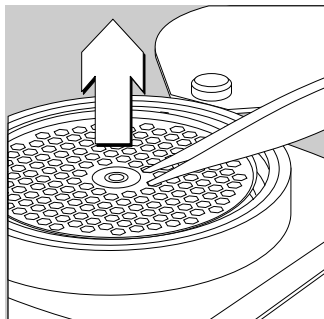

Model CP2P-F:

- Remove the filter pan lid from the chamber
- Use forceps to remove the filter weighing pan carefully from the chamber
- Remove the interior draft shield from the chamber:  
Use your fingers to raise the draft shield carefully until it is free
- Place these parts either in the accessory kit or in the original packaging

The balance/scale must be conditioned again any time it is set up in a new location (see "Installation Instructions" on page 6).

---

# Care and Maintenance

## Service

Regular servicing by a Sartorius technician will extend the service life of your balance/scale and ensure its continued weighing accuracy. Sartorius can offer you service contracts, with your choice of regular maintenance intervals ranging from 1 month to 2 years.

The optimum maintenance interval depends on the operating conditions at the place of installation and on the individual tolerance requirements.

## Repairs

Repair work must be performed by trained service technicians. Any attempt by untrained persons to perform repairs may lead to hazards for the user.

## Cleaning

- △ Unplug the AC adapter from the wall outlet (mains supply). If you have an interface cable connected to the balance/scale port, unplug it from the port.
- △ Make sure that no liquid enters the balance/scale housing
- △ Do not use any aggressive cleaning agents (solvents or similar agents)
- Clean the balance/scale using a piece of cloth which has been wet with a mild detergent (soap)
- After cleaning, wipe down the balance/scale with a soft, dry cloth

## Cleaning Stainless Steel Surfaces

Clean all stainless steel parts regularly. Remove the stainless steel weighing pan and thoroughly clean it separately. Use a damp cloth or sponge to clean any stainless steel parts on the scale. You can use any commercially available household cleaning agent that is suitable for use on stainless steel. Clean stainless steel surfaces by wiping them down. Then clean the weighing pan thoroughly, making sure to remove all residues. Use a damp cloth or sponge to wipe down any stainless steel parts on the scale again. Afterwards, allow the scale to dry. If desired, you can apply oil to the cleaned surfaces as additional protection.

- △ Do not use stainless steel cleaning agents that contain soda lye (caustic), acetic acid, hydrochloric acid, sulfuric acid or citric acid. The use of scrubbing sponges made of steel wool is not permitted. Solvents are permitted for use only on stainless steel parts.

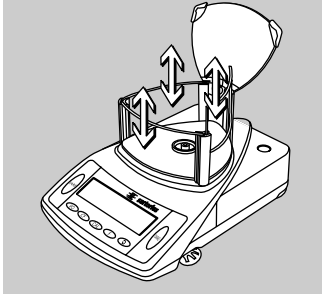

### **Cleaning the Weighing Chamber and Draft Shield**

- Open the draft shield cover and take out the removable parts
- Use a hand-held vacuum cleaner and mini-hose to remove any powdered sample material carefully.
- Use blotting paper to remove any liquid sample material.
- On models with a 3-sided draft shield, pull the 3 draft shield walls upwards to remove, if necessary.

### **Safety Inspection**

If there is any indication that safe operation of the balance/scale with the AC adapter is no longer warranted:

- Turn off the power and disconnect the equipment from AC power immediately
- > Lock the equipment in a secure place to ensure that it cannot be used for the time being

Safe operation of the balance/scale with the AC adapter is no longer ensured when:

- there is visible damage to the AC adapter.
  - the AC adapter no longer functions properly.
  - the AC adapter has been stored for a relatively long period under unfavorable conditions.
- Maintenance and repair work may be performed only by service technicians who are authorized by Sartorius and who
- have access to the required maintenance manuals.
  - have attended the relevant service training courses.

We recommend having the power supply inspected by a certified electrician at regular intervals, according to the checklist given below:

- Insulating resistance > 7 megaohms measured with a constant voltage of at least 500 V at a 500 kohm load
- Leakage current: < 0.05mA measured with a properly calibrated multimeter

---

## Instructions for Recycling the Packaging

To ensure safe shipment, your balance/scale has been packaged using environmentally friendly materials. After successful installation of the balance/scale, you should return this packaging for recycling.

For information on recycling options, including recycling of old weighing equipment, contact your municipal waste disposal center or local recycling depot.

# Overview

## Specifications

### Competence Series/CP Series

Model		CP2P	CP2P-F
Weighing capacity	mg	500/1000/2000	500/1000/2000
Max. loading capacity	mg	approx. 2000	approx. 2000
Readability	mg	0.001/0.002/0.005	0.001/0.002/0.005
Tare range (subtractive)	mg	approx. -2000	approx. -2000
Repeatability (std. deviation)	≤± mg	0.001/0.002/0.003	0.002/0.003/0.004
Linearity	≤± mg	0.002/0.004/0.005	0.002/0.004/0.005
Response (average)	s	10	10
Operating temperature range	°C	+15.... +30°C (59°F to 86°F)	
Allowable ambient operating temperature	°C	+5.... +40°C (41°F to 104°F)	
Sensitivity drift within +15... +30°C	≤±/K	5 · 10 <sup>-6</sup>	
External calibration weight (of at least accuracy class...)	g	2 (E2)	2 (E2)
Weighing pan diameter	mm	20 Ø	125 Ø or 20 Ø
Dimensions (W×D×H)	mm	213×342×151	213×342×115
Weighing chamber (W×D×H)	mm	54×49.5×55.5	Height: 12
Net weight, approx.	kg	4.35	5.0
AC power source/ Power requirements	V~	AC adapter, 230 V or 115 V, +15%...-20% (protection rating IP20)	
Frequency	Hz	48 – 60	
Power consumption (average)	VA	maximum 16; typical 8	
Approx. hours of operation with the YRB08Z rechargeable battery pack	h	22	22
Selectable weight units		Grams, carats, pounds, ounces, Troy ounces, Hong Kong taels, Singapore taels, Taiwanese taels, grains, pennyweights, milligrams, parts per pound, Chinese taels, mommes, Austrian carats, tola, baht and mesghal	
Built-in interface		RS-232/V24-V28	
Format:		7-bit ASCII, 1 start bit, 1 or 2 stop bits	
Parity:		Mark, odd, even or space	
Transmission rates:		150 to 19,200 baud	
Handshake mode:		Software or hardware	

## Competence Series/CP Series

Model		CP225D	CP324S	CP224S	CP124S	CP64	CP64-WDS
Weighing capacity	g	40/80/220	320	220	120	64	64
Readability	mg	0.01/0.01/0.1	0.1	0.1	0.1	0.1	0.1
Tare range (subtractive)	g	-220	-320	-220	-120	-64	-64
Repeatability (std. deviation)	≤±mg	0.02/0.05/0.1	0.2	0.1	0.1	0.1	0.1
Linearity	≤±mg	0.03/0.1/0.2	0.3	0.2	0.2	0.2	0.2
Response time (average)	s	≤ 12/3	≤ 3	≤ 2	≤ 2	≤ 2	≤ 2
Operating temperature range	°C	+10.... +30°C (50° to 86°F)					
Allowable ambient operating temperature	°C	+5.... +40°C (41°F to 104°F)					
Sensitivity drift within +10... +30°C	≤±/K	1 · 10 <sup>-6</sup>					
External calibration weight (of at least accuracy class...)	g	200 (E2)	200 + 100 (E2)	200 (E2)	100 (E2)	50 (E2)	50 (E2)
Net weight, approx.	kg	7.6	6.5	6.5	6.5	6.5	4.1
Pan size (inner diameter)*	mm	80 ∅					
Pan surface*	cm <sup>2</sup>	64					
Weighing chamber height (from pan to cover)	mm	232	232	232	232	232	-
Dimensions (WxDxH)	mm	213x342x340					
Electronics box (WxDxH)	mm	134x51x155	-	-	-	-	-
AC power source/ Power requirements	V~	AC adapter, 230 V or 115 V, +15%...-20% (protection rating IP20)					
Frequency	Hz	48 – 60					
Power consumption (average)	VA	maximum 16; typical 8					
Approx. hours of operation with the YRB08Z rechargeable battery pack	h	20	22	22	22	22	22
Selectable weight units		Grams, carats, pounds, ounces, Troy ounces, Hong Kong taels, Singapore taels, Taiwanese taels, grains, pennyweights, milligrams, parts per pound, Chinese taels, mommes, Austrian carats, tola, baht and mesghal					
Built-in interface		RS-232/V24-V28					
Format:		7-bit ASCII, 1 start bit, 1 or 2 stop bits					
Parity:		Mark, odd, even or space					
Transmission rates:		150 to 19,200 baud					
Handshake mode:		Software or hardware					



\* Three-sided weighing pan: ∅ = Diameter of inner circle.  
The cross-hatched section can be fully utilized.

## Gem<sup>plus</sup> Series

Model		GC1603P	GC803S	GC803P	GC2502
Weighing capacity	ct	800/1,600	800	400/800	2,500 (500 g)
Readability	ct	0.001/0.01	0.001	0.001/0.01	0.01 <sup>1)</sup>
Tare range (subtractive)	ct	-1,600	-800	-800	-2,500
Repeatability (std. deviation)	± ct	0.001/0.01	0.001	0.001/0.01	0.01
Linearity	± ct	0.002	0.001	0.001	0.01
Response time (average)	s	≤ 2			
Operating temperature range	°C	+10... +30°C (50°F to 86°F)			
Allowable ambient operating temperature	°C	+5... +40°C (41°F to 104°F)			
Sensitivity drift within +10... +30°C	±/K	1 · 10 <sup>-6</sup>	1 · 10 <sup>-6</sup>	1 · 10 <sup>-6</sup>	2 · 10 <sup>-6</sup>
External calibration weight (of at least accuracy class...)	g	200 + 100 (E2)	100 (E2)	100 (E2)	200 (F1)
Net weight, approx.	kg	6.1			
Pan size (inner diameter)*	mm	80 Ø	80 Ø	80 Ø	110 Ø
Pan surface*	cm <sup>2</sup>	64	64	64	120
Weighing chamber height (from pan to cover)	mm	162			
Dimensions (WxDxH)	mm	213x342x270			
AC power source/ Power requirements	V~	AC adapter, 230 V or 115 V, +15%...-20% (protection rating IP20)			
Frequency	Hz	48 – 60			
Power consumption (average)	VA	maximum 16; typical 8			
Approx. hours of operation with the YRB08Z rechargeable battery pack	h	22	22	22	27
Selectable weight units		Grams, carats, pounds, ounces, Troy ounces, Hong Kong taels, Singapore taels, Taiwanese taels, grains, pennyweights, milligrams, parts per pound, Chinese taels, mommes, Austrian carats, tola, baht and mesghal			
Built-in interface		RS-232/V24-V28			
Format:		7-bit ASCII, 1 start bit, 1 or 2 stop bits			
Parity:		Mark, odd, even or space			
Transmission rates:		150 to 19,200 baud			
Handshake mode:		Software or hardware			

<sup>1)</sup> For readability 0.005 ct, select menu code 1 8 1 or 3 2 1 (see "Configuring the Balance/Scale")



\* Three-sided weighing pan: Ø = Diameter of inner circle.  
The cross-hatched section can be fully utilized.

## Competence Series/CP Series

Model		CP423S, CP423S-DS	CP323S, CP323S-DS	CP323P	CP153
Weighing capacity	g	420	320	80/160/320	150
Readability	g	0.001	0.001	0.001/0.002/ 0.005	0.001
Tare range (subtractive)	g	-420	-320	-320	-150
Repeatability (std. deviation)	≤± g	0.001	0.001	0.001/0.001/ 0.003	0.001
Linearity	≤± g	0.002	0.002	0.002/0.002/ 0.005	0.001
Response time (average)	s	≤ 1.5			
Operating temperature range	°C	+10....+30°C (50°F to 86°F)			
Allowable ambient operating temperature	°C	0....+40°C (32°F to 104°F)			
Sensitivity drift within +10...+30°C	≤±/K	2 · 10 <sup>-6</sup>			
External calibration weight (of at least accuracy class...)	g	200 (F1)	200 (F1)	100 (F1)	100 (F1)
Net weight, approx.	kg	3.7			
Pan size (inner diameter)*	mm	110 Ø			
Pan surface*	cm <sup>2</sup>	120			
Weighing chamber height (from pan to cover)	mm	CP423S: 50 CP423S-DS: 232	CP323S: 50 CP423S-DS: 232	50	50
Dimensions (W×D×H)	mm	213×342×153; CP...-DS: 213×342×340			
AC power source/ Power requirements	V~	AC adapter, 230 V or 115 V, +15%...-20% (protection rating IP20)			
Frequency	Hz	48 – 60			
Power consumption (average)	VA	maximum 16; typical 8			
Approx. hours of operation with the YRB08Z rechargeable battery pack	h	27			
Selectable weight units		Grams, carats, pounds, ounces, Troy ounces, Hong Kong taels, Singapore taels, Taiwanese taels, grains, pennyweights, milligrams, parts per pound, Chinese taels, mommes, Austrian carats, tola, baht and mesghal			
Built-in interface		RS-232/V24-V28			
Format:		7-bit ASCII, 1 start bit, 1 or 2 stop bits			
Parity:		Mark, odd, even or space			
Transmission rates:		150 to 19,200 baud			
Handshake mode:		Software or hardware			



\* Three-sided weighing pan: Ø = Diameter of inner circle.  
The cross-hatched section can be fully utilized.



## Competence/CP Series and Gem<sup>plus</sup> Series

Model		CP4202S	CP3202S, GP3202	CP3202P	CP2202S
Weighing capacity	g	4,200	3,200	800/1,600/ 3,200	2,200
Readability	g	0.01	0.01	0.01/0.02/ 0.05	0.01
Tare range (subtractive)	g	-4,200	-3,200	-3,200	-2,200
Repeatability (std. deviation)	± g	0.01	0.01	0.01/0.01/0.03	0.01
Linearity	± g	0.02	0.02	0.02/0.02/0.05	0.02
Response time (average)	s	≤ 1.5			
Operating temperature range	°C	+10...+30°C (50°F to 86°F)			
Allowable ambient operating temperature	°C	0...+40°C (32°F to 104°F)			
Sensitivity drift within +10...+30°C	±/K	2 · 10 <sup>-6</sup>			
External calibration weight (of at least accuracy class...)	g	2,000 (F1)	2,000 (F1)	1,000 (F1)	1,000 (F1)
Net weight, approx.	kg	4.0			
Pan size	mm	190×204			
Pan surface	cm <sup>2</sup>	369			
Dimensions (W×D×H)	mm	213×342×88			
AC power source/ Power requirements	V~	AC adapter, 230 V or 115 V, +15%...-20% (protection rating IP20)			
Frequency	Hz	48 – 60			
Power consumption (average)	VA	maximum 16; typical 8			
Approx. hours of operation with the YRB08Z rechargeable battery pack	h	27			
Selectable weight units		Grams, kilograms, carats, pounds, ounces, Troy ounces, Hong Kong taels, Singapore taels, Taiwanese taels, grains, pennyweights, milligrams, parts per pound, Chinese taels, mommes, Austrian carats, tola, baht and mesghal			
Built-in interface		RS-232/V24-V28			
Format:		7-bit ASCII, 1 start bit, 1 or 2 stop bits			
Parity:		Mark, odd, even or space			
Transmission rates:		150 to 19,200 baud			
Handshake mode:		Software or hardware			

## Competence Series/CP Series

Model		CP622	CP8201, GP8201	CP6201	CP4201	CP2201
Weighing capacity	g	620	8,200	6,200	4,200	2,200
Readability (scale interval)	g	0.01	0.1	0.1	0.1	0.1
Tare range (subtractive)	g	-620	-8,200	-6,200	-4,200	-2,200
Repeatability (std. deviation)	$\leq \pm g$	0.01	0.1	0.1	0.1	0.1
Linearity	$\leq \pm g$	0.02	0.2	0.2	0.2	0.2
Response time (average)	s	$\leq 1$				
Operating temperature range	°C	+10...+30°C (50°F to 86°F)				
Allowable ambient operating temperature	°C	0...+40°C (32°F to 104°F)				
Sensitivity drift within +10...+30°C	$\leq \pm/K$	$5 \cdot 10^{-6}$	$5 \cdot 10^{-6}$	$5 \cdot 10^{-6}$	$10 \cdot 10^{-6}$	$10 \cdot 10^{-6}$
External calibration weight (of at least accuracy class...)	g	500 (F2)	5,000 (F1)	5,000 (F2)	2,000 (F2)	2,000 (F2)
Net weight, approx.	kg	2.8	3.6	3.6	3.6	3.6
Pan size	mm	154 $\varnothing^*$	190×204	190×204	190×204	190×204
Pan surface	cm <sup>2</sup>	227*	369	369	369	369
Dimensions (W×D×H)	mm	213×342×90				
AC power source/ power requirements	V~	AC adapter, 230 V or 115 V, +15%...-20% (protection rating IP20)				
Frequency	Hz	48 – 60				
Power consumption (average)	VA	maximum 16; typical 8				
Approx. hours of operation with the YRB05Z rechargeable battery pack	h	40				
Selectable weight units		Grams, kilograms, carats, pounds, ounces, Troy ounces, Hong Kong taels, Singapore taels, Taiwanese taels, grains, pennyweights, milligrams, parts per pound, Chinese taels, mottes, Austrian carats, tola, baht and mesghal				
Built-in interface		RS-232/V24-V28				
Format:		7-bit ASCII, 1 start bit, 1 or 2 stop bits				
Parity:		Mark, odd, even or space				
Transmission rates:		150 to 19,200 baud				
Handshake mode:		Software or hardware				



\* Three-sided weighing pan:  $\varnothing$  = Diameter of inner circle.  
The cross-hatched section can be fully utilized.

## Competence Series/CP Series

Model		CP34001S	CP34001P	CP16001S	CP12001S	CP34000
Weighing capacity	kg	34	8/16/34	16	12	34
Readability (scale interval)	g	0.1	0.1/0.2/0.5	0.1	0.1	1
Tare range (subtractive)	kg	-34	-34	-16	-12	-34
Repeatability (std. deviation)	≤±g	0.1	0.05/0.05/0.1	0.05	0.05	0.5
Linearity	≤±g	0.2	0.2	0.2	0.2	0.5
Response time (average)	s	≤ 2	≤ 2	≤ 2	≤ 2	≤ 1.5
Operating temperature range	°C	+10...+30°C (50°F to 86°F)				
Allowable ambient operating temperature	°C	0...+40°C (32°F to 104°F)				
Sensitivity drift within +10...+30°C	≤±/K	2·10 <sup>-6</sup>				
External calibration weight (of at least accuracy class...)	kg	10 (F1)	10 (F2)	10 (F1)	10 (F1)	10 (F2)
Net weight, approx.	kg	16				
Pan size	mm	300x400				
Dimensions (WxDxH)	mm	313x532x120				
AC power source/ Power requirements	V~	AC adapter, 230 V or 115 V, (protection rating IP20)				
Frequency	Hz	48 – 60				
Power consumption (average)	VA	maximum 16; typical 8				
Approx. hours of operation with the YRB06Z rechargeable battery pack	h	22				
Selectable weight units		Grams, kilograms, carats, pounds, ounces, Troy ounces, Hong Kong taels, Singapore taels, Taiwanese taels, grains, pennyweights, milligrams, parts per pound, Chinese taels, mommes, Austrian carats, tola, baht and mesghal				
Built-in interface		RS-232/V24-V28				
Format:		7-bit ASCII, 1 start bit, 1 or 2 stop bits				
Parity:		Mark, odd, even or space				
Transmission rates:		150 to 19,200 baud				
Handshake mode:		Software or hardware				

## Specifications

### Verified models with EC type approval

#### Competence Series/CP Series

Model		CP225D-OCE	CP324S-OCE	CP224S-OCE, CP224S-PCE	CP124S-OCE, CP124S-ACE	CP64-OCE
Type		BC BL 100	BC BL 100	BC BL 100	BC BL 100	BC BL 100
Accuracy class <sup>1)</sup>						
Maximum capacity, Max. <sup>1)</sup>	g	80/220	320	220	120	64
Scale interval, d <sup>1)</sup>	mg	0.01/0.1	0.1	0.1	0.1	0.1
Tare range (subtractive)	g	≤ 100% of the maximum capacity				
Verification scale interval, e <sup>1)</sup>	g	0.001	0.001	0.001	0.001	0.001
Minimum capacity, Min. <sup>1)</sup>	g	0.001	0.01	0.01	0.01	0.01
Stabilization time (average)	s	≤ 6/3	≤ 3	≤ 2	≤ 2	≤ 2
Range of use (according to CD <sup>1)</sup> )	g	0.001-220	0.01-320	0.01-220	0.01-120	0.01-64
Allowable ambient operating temperature	°C	+15... +25 (59°F to 77°F)				
External calibration weight (of at least accuracy class)	g	200 (E2)	200 + 100 (E2)	200 (E2)	100 (E2)	50 (E2)
Net weight, approx.	kg	7.6	6.5	6.5	6.5	6.5
Pan size (inner diameter)*	mm	80 ∅				
Pan area*	cm <sup>2</sup>	64				
Weighing chamber height (from pan to sliding cover)	mm	232				
Dimensions (WxDxH)	mm	213x342x340				
Electronics box (WxDxH)	mm	134x51x155	-	-	-	-
AC power source/ Power requirements	V~	AC adapter STNG6 230 VAC or 115 VAC, +15%...-20% (protection rating IP20)				
Frequency	Hz	48 - 60				
Power consumption (average)	VA	maximum: 16; average: 8				
Approx. hours of operation with the YRB05Z rechargeable battery pack	h	20	22	22	22	22
Selectable weight units		Grams, milligrams, carats				Grams, carats
Built-in interface		RS-232C-S/V24-V28; 7-bit; parity: even, mark, odd, space; transmission rates 150...19,200 baud; 1 or 2 stop bits; software/hardware handshake				

<sup>1)</sup> CD = Council Directive 90/384/EEC on non-automatic weighing instruments; applicable to the European Economic Area



\* Three-sided weighing pan: ∅ = Diameter of inner circle.  
The cross-hatched section can be fully utilized.

## Gem<sup>plus</sup> Series

Model		GC1603S-OCE	GC803S-OCE
Type		BC BL 100	BC BL 100
Accuracy class <sup>1)</sup>		Ⓛ	Ⓛ
Maximum capacity, Max. <sup>1)</sup>	ct	1,600	800
Readability	ct	0.001	0.001
Tare range (subtractive)	ct	≤ 100% of the maximum capacity	
Verification scale interval, e <sup>1)</sup>	mct	10	10
Minimum capacity, Min. <sup>1)</sup>	ct	0.1	0.1
Stabilization time (average)	s	≤ 2	
Range of use according to CD <sup>1)</sup>	ct	0.1–1,600	0.1–800
Allowable ambient operating temperature	°C	+15... +25 (59°F to 77°F)	
External calibration weight (of at least accuracy class)	g	200 + 100 (E2)	100 (E2)
Net weight, approx.	kg	6.1	
Pan size (inner diameter)*	mm	80 ∅	80 ∅
Pan area*	cm <sup>2</sup>	64	
Weighing chamber height (from pan to sliding cover)	mm	162	
Dimensions (WxDxH)	mm	213x342x270	
AC power source/ Power requirements	V~	AC adapter STNG6 230 VAC or 115 VAC, +15%...-20% (protection rating IP20)	
Frequency	Hz	48 – 60	
Power consumption (average)	VA	maximum: 16; average: 8	
Approx. hours of operation with the YRB05Z rechargeable battery pack	h	22	22
Selectable weight units		Grams, milligrams, carats	
Built-in interface		RS-232C-S/V24-V28; 7-bit; parity: even, mark, odd, space; transmission rates 150...19,200 baud; 1 or 2 stop bits; software/hardware handshake	

<sup>1)</sup> CD = Council Directive 90/384/EEC on non-automatic weighing instruments; applicable to the European Economic Area



\* Three-sided weighing pan: ∅ = Diameter of inner circle. The cross-hatched section can be fully utilized.

## Competence Series/CP Series

Model		CP523S-PCE	CP423S-OCE	CP323S-OCE	CP323P-OCE	CP153-OCE, CP153-PCE
Type		BD BL 200	BD BL 200	BD BL 200	BD BL 200	BD BL 200
Accuracy class <sup>1)</sup>		II	II	II	II	II
Maximum capacity, Max. <sup>1)</sup>	g	520	420	320	80/160/320	150
Scale interval, d <sup>1)</sup>	g	0.001	0.001	0.001	0.001/0.002/ 0.005	0.001
Tare range (subtractive)	g	≤ 100% of the maximum capacity				
Verification scale interval, e <sup>1)</sup>	g	0.01	0.01	0.01	0.01	0.01
Minimum capacity, Min. <sup>1)</sup>	g	0.02	0.02	0.02	0.02	0.02
Response time (average)	s	≤ 1.5				
Range of use according to CD <sup>1)</sup>	g	0.02–520	0.02–420	0.01–320	0.02–320	0.02–150
Allowable ambient operating temperature	°C	+10...+30 (50°F to 86°F)				
Net weight, approx.	kg	4.6				
Pan size (inner diameter)*	mm	110 Ø				
Pan area*	cm <sup>2</sup>	120				
Weighing chamber height (from pan to sliding cover)	mm	50				
Dimensions (W×D×H)	mm	213×342×153				
AC power source/ Power requirements	V~	AC adapter STNG6 230 VAC or 115 VAC, +15%...-20% (protection rating IP20)				
Frequency	Hz	48 – 60				
Power consumption (average)	VA	maximum: 16; average: 8				
Approx. hours of operation with the YRB05Z rechargeable battery pack	h	27				
Selectable weight units		Grams, carats				
Built-in interface		RS-232C-S/V24-V28; 7-bit; parity: even, mark, odd, space; transmission rates 150...19,200 baud; 1 or 2 stop bits; software/hardware handshake				

<sup>1)</sup> CD = Council Directive 90/384/EEC on non-automatic weighing instruments; applicable to the European Economic Area



\* Three-sided weighing pan: Ø = Diameter of inner circle.  
The cross-hatched section can be fully utilized.

## Competence/CP and Gem<sup>plus</sup> Series

Model		CP4202S-OCE, CP4202S-ACE, CP4202S-PCE	CP3202S-OCE, CP3202S-ACE, GP3202-OCE	CP3202P-OCE	CP2202S-OCE
Type		BD BL 200	BD BL 200	BD BL 200	BD BL 200
Accuracy class <sup>1)</sup>		II	II	II	II
Maximum capacity, Max. <sup>1)</sup>	g	4,200	3,200	800/1,600/ 3,200	2,200
Scale interval, d <sup>1)</sup>	g	0.01	0.01	0.01/0.02/ 0.05	0.01
Tare range (subtractive)	g	≤ 100% of the maximum capacity			
Verification scale interval, e <sup>1)</sup>	g	0.1	0.1	0.1	0.1
Minimum capacity, Min. <sup>1)</sup>	g	0.5	0.5	0.5	0.5
Response time (average)	s	≤ 1.5			
Range of use according to CD <sup>1)</sup>	g	0.5–4,200	0.5–3,200	0.5–3,200	0.5–2,200
Allowable ambient operating temperature	°C	+10...+30 (50° to 86°F)			
Net weight, approx.	kg	4.7			
Pan size	mm	190×204			
Pan area	cm <sup>2</sup>	369			
Dimensions (W×D×H)	mm	213×342×88			
AC power source/ Power requirements	V~	AC adapter STNG6 230 VAC or 115 VAC, +15%...–20% (protection rating IP20)			
Frequency	Hz	48 – 60			
Power consumption (average)	VA	maximum: 16; average: 8			
Approx. hours of operation with the YRB05Z rechargeable battery pack	h	27			
Selectable weight units		Grams, kilograms, carats			
Built-in interface		RS-232C-S/V24-V28; 7-bit; parity: even, mark, odd, space; transmission rates 150...19,200 baud; 1 or 2 stop bits; software/hardware handshake			

<sup>1)</sup> CD = Council Directive 90/384/EEC on non-automatic weighing instruments; applicable to the European Economic Area

## Competence Series/CP Series

Model		CP622-0CE	CP8201-0CE	CP6201-0CE	CP5201-PCE	CP2201-0CE
Type		BD BL 200	BD BL 200	BD BL 200	BD BL 200	BD BL 200
Accuracy class <sup>1)</sup>		Ⓜ	Ⓜ	Ⓜ	Ⓜ	Ⓜ
Maximum capacity, Max. <sup>1)</sup>	g	620	8,200	6,200	5,200	2,200
Scale interval, d <sup>1)</sup>	g	0.01	0.1	0.1	0.1	0.1
Tare range (subtractive)	g	≤ 100% of the maximum capacity				
Verification scale interval, e <sup>1)</sup>	g	0.1	1	1	1	0.1
Minimum capacity, Min. <sup>1)</sup>	g	0.5	5	5	5	5
Response time (average)	s	≤ 1				
Range of use according to CD <sup>1)</sup>	g	0.5-620	5-8,200	5-6,200	5-5,200	5-2,200
Allowable ambient operating temperature	°C	+10...+30 (50°F to 86°F)				
Net weight, approx.	kg	4.7				
Pan size	mm	190×204				
Pan area	cm <sup>2</sup>	369				
Dimensions (W×D×H)	mm	213×342×90				
AC power source/ Power requirements	V~	AC adapter STNG6 230 VAC or 115 VAC, +15%...-20% (protection rating IP20)				
Frequency	Hz	48 - 60				
Power consumption (average)	VA	maximum: 16; average: 8				
Approx. hours of operation with the YRB05Z rechargeable battery pack	h	40				
Selectable weight units		Grams, kilograms, carats				
Built-in interface		RS-232C-S/V24-V28; 7-bit; parity: even, mark, odd, space; transmission rates 150...19,200 baud; 1 or 2 stop bits; software/hardware handshake				

<sup>1)</sup> CD = Council Directive 90/384/EEC on non-automatic weighing instruments; applicable to the European Economic Area



## Competence Series/CP Series

Model		CP34001S-OCE	CP34001P-OCE	CP16001S-OCE	CP12001S-OCE	CP34000-OCE
Type		BF BL 500	BF BL 500	BF BL 500	BF BL 500	BF BL 500
Accuracy class <sup>1)</sup>		Ⓜ	Ⓜ	Ⓜ	Ⓜ	Ⓜ
Maximum capacity, Max. <sup>1)</sup>	kg	34	8/16/34	16	12	34
Scale interval, d <sup>1)</sup>	g	0.1	0.1/0.2/0.5	0.1	0.1	1
Tare range (subtractive)	g	≤ 100% of the maximum capacity				
Verification scale interval, e <sup>1)</sup>	g	1	1	1	1	1
Minimum capacity, Min. <sup>1)</sup>	g	5	5	5	5	50
Response time (average)	s	≤ 2	≤ 2	≤ 2	≤ 2	≤ 1.5
Range of use according to CD <sup>1)</sup>	g	5–34,000	5–34,000	5–16,000	5–12,000	150–34,000
Allowable ambient operating temperature	°C	+10...+30 (50°F to 86°F)				
Net weight, approx.	kg	16				
Pan size	mm	300×400				
Dimensions (W×D×H)	mm	313×532×120				
AC power source/ Power requirements	V~	AC adapter STNG6-2 230 VAC or 115 VAC, +15%...-20% (protection rating IP20)				
Frequency	Hz	48 – 60				
Power consumption (average)	VA	maximum: 16; average: 8				
Approx. hours of operation with the YRB06Z rechargeable battery pack	h	22				
Selectable weight units		Grams, kilograms, carats				
Built-in interface		RS-232C-S/V24-V28; 7-bit; parity: even, mark, odd, space; transmission rates 150...19,200 baud; 1 or 2 stop bits; software/hardware handshake				

<sup>1)</sup> CD = Council Directive 90/384/EEC on non-automatic weighing instruments; applicable to the European Economic Area

## Accessories (Options)

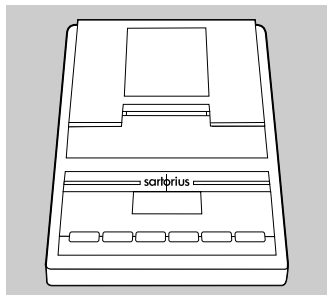

Product

**Data printer**  
with date/time, statistics  
evaluation and transaction  
counter functions and LCD

Order No.

**YDP03-OCE**

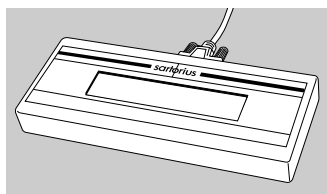

**Remote display, reflective**  
(data interface required)

**YRD02Z**

**Remote display, transmissive**  
(for overhead projectors)  
(data interface required)

**YRD13Z**



**External rechargeable battery pack**

- for models with weighing capacities under 10 kg
- for models with weighing capacities over 10 kg
- > with battery-level indicator (LED); can be recharged using the AC adapter (time it takes to charge the discharged battery pack: 15 hours); see "Specifications" for hours of operation

**YRB05Z**

**YRB06Z**

To recharge the battery pack:

- Unplug the AC adapter from the balance/scale and plug it into the battery pack

**Carrying case**

- for models with analytical draft shield chamber
- for models with weighing capacities up to 10 kg and without analytical draft shield chamber

**YDB01CP**

**YDB02CP**

### Calibration weights:

For model:	Accuracy class (OIML)	Weight in grams	Order no.*:
CP2P..	E2	1×2	YCW3228-00
CP64	E2	1×50	YCW4528-00
CP124S, GC803S, GC803P	E2	1×100	YCW5128-00
CP323P, CP153	F1	1×100	YCW5138-00
CP225D, CP224S	E2	1×200	YCW5228-00
CP324S, GC1603P	E2	1×200+ 1×100	YCW5228-00+ YCW5128-00
CP423S, CP323S, GC2502	F1	1×200	YCW5238-00
CP622	F2	1×500	YCW5548-00
CP3202P, CP2202S	F1	1×1000	YCW6138-00
CP4202S, CP3202S, GP3202, CP4201, CP2201	F1	1×2000	YCW6238-00
CP8201, CP6201	F1	1×5000	YCW6538-00
CP34001S, CP34001P, CP16001S, CP12001S, CP34000	F1	1×10000	YCW7138-00

### SartoConnect data transfer software

for connecting your Sartorius balance/scale to a PC running the Windows 95, 98 or NT operating system.

This software lets you transfer the data recorded by your balance/scale to any PC application program (e.g., Excel).

YSC01L

### Density determination kit

- for CP225D, CP324S, CP124S, CP64

YDK01

### Antistatic weighing pan

- for CP225D, CP324S, CP124S, CP64

YWP01CP

### Dust cover

for precision balances/scales

Information on request

\* = All weights can also be supplied with a DKD certificate, if requested by adding -02 to the order number (YCW....-02); DKD certificates issued by the German Calibration Service are recognized throughout the member states of the Western European Calibration Cooperation

Product	Order No.
<b>Industrial AC adapter, model ING1</b> for balances/scales with weighing capacities of up to 10 kg; protection rating: IP65 in accordance with DIN VDE 0470/ DIN EN 60529	
– for 230 V	<b>69 71476</b>
– for 120 V	<b>69 71480</b>
<b>Industrial AC adapter, model ING2</b> for balances/scales with weighing capacities over 10 kg; protection rating: IP65 in accordance with DIN VDE 0470/ DIN EN 60529	
– for 230 V	<b>69 71899</b>
– for 120 V	<b>69 71500</b>
<b>Analytical draft shield chamber</b> – for CP423S, CP323S, CP323P, CP153, GC2502	<b>YDS01CP</b>
<b>Draft shield cover with opening</b> – for CP423S, CP323S, CP323P, CP153, GC2502	<b>YDS02CP</b>
<b>Data cable</b> – for PC connection, 25-pin – for PC connection, 9-pin	<b>7357312</b> <b>7357314</b>
<b>Adapter:</b> D-Sub 25-pin to D-Sub 9-position; length: 0.25 m	<b>6965619</b>
<b>Universal remote control switch</b> for remote control of one of the following functions (configured in the balance/scale menu): (see “Configuration” for details): Foot switch with T-connector Hand switch with T-connector	<b>YFS01</b> <b>YHS02</b>
<b>T-connector</b>	<b>YTC01</b>
▲ The T-connector is not intended for use with multiple intelligent peripheral devices, such as PCs or YDP03–OCE printers.	

---

# Declaration of Conformity

## **Weighing Instruments for Use in Legal Metrology:**

### **Council Directive 90/384/EEC**

#### **“Non-automatic weighing instruments”**

This Directive regulates the determination of mass in legal metrology.

For the respective Declaration of Type Conformity for weighing instruments that have been verified by Sartorius for use as legal measuring instruments and that have an EC Type-Approval Certificate, see the page after next.

This Directive also regulates the performance of the EC verification by the manufacturer, provided that an EC Type-Approval Certificate has been issued and the manufacturer has been accredited by an officer of a Notified Body registered at the Commission of the European Community for performing such verification.

Sartorius complies with EC Directive No. 90/384/EEC for non-automatic weighing instruments, which has been in effect since January 1, 1993, within the Single European Market, as well as the accreditation of the Quality Management System of Sartorius AG by Lower Saxony's Regional Administrative Department of Legal Metrology (Niedersächsisches Landesverwaltungsamt – Eichwesen) from February 15, 1993.

For additional information on the **CE** mark on Sartorius equipment, see Sartorius Publication No. W--0052-e93081.

## **“New Installation” Service**

Initial verification is covered in our “New Installation” service package. In addition to initial verification, this package provides you with a series of important services which will guarantee you optimal results in working with your weighing instrument:

- Installation
- Startup
- Inspection
- Training
- Initial verification

## **“EC Verification” – A Service Offered by Sartorius**

Our service technicians authorized to perform the verification\* of your weighing instruments that are acceptable for legal metrological verification can inspect and verify the metrological specifications at the place of installation within the Member States of the European Union and the Signatories of the Agreement on the European Economic Area.

## **Subsequent Verifications within the European Countries**

The validity of the verification will become void in accordance with the national regulations of the country in which the weighing instrument is used. For information on verification and legal regulations currently applicable in your country, and to obtain the names of the persons to contact, please contact your local Sartorius office, dealer or service center.

For more information on the verification of weighing instruments for use in legal metrology, contact the Sartorius Service Center.

\* = in accordance with the accreditation certificate received by Sartorius AG



# Declaration of Conformity to Council Directives 89/336/EEC and 73/23/EEC

The electronic precision weighing instrument of the series CP/GP/GC.....-...

meets the requirements of the test standards listed below, in conjunction with the associated power supplies, auxiliary, peripheral devices and installation equipment listed in Annex A2 (see Annex A1 for a technical description and variants).

## 1. Electromagnetic Compatibility

1.1 Source for 89/336/EEC: EC Official Journal, No. 2000/C99/03

EN 61326-1 Electrical equipment for measurement, control and laboratory use

EMC requirements

Part 1: General requirements

Emission: Residential areas, Class B

Immunity: Industrial areas, continuous unmonitored operation.

## 2. Safety of Electrical Equipment

2.1 Source for 73/23/EEC: EC Official Journal, No. 2000/C108/08

EN 61010 Safety requirements for electrical equipment for measurement, control and laboratory use

Part 1: General requirements

EN 60950 Safety of information technology equipment including electrical business equipment

Sartorius AG  
37070 Goettingen, Germany  
2001

Dr. G. Maaz  
(Senior Vice President, R&D  
Technical Operations, Mechanical  
Engineering  
Mechatronics Division)

C. Oldendorf  
(Senior Vice President, R&D  
Electronic Engineering  
Mechatronics Division)



# Declaration of Type Conformity to Directive No. 90/384/EEC

This declaration is valid for non-automatic electromechanical weighing instruments for use in legal metrology. These weighing instruments accepted for legal metrological verification have an EC Type-Approval Certificate. The model(s) concerned is(are) listed below along with the respective type, accuracy class, and number of the EC Type-Approval Certificate:

Model	Type	Accuracy Class	EC Type Approval No.
CP...-OCE	BC BL 100	Ⓛ	D01-09-019
CP...-ACE	BC BL 100	Ⓛ	D01-09-019
CP...-OCEV1	BD BL 100	Ⓛ	D01-09-019
CP...-ACEV1	BD BL 100	Ⓛ	D01-09-019
CP...-PCE	BD BL 100	Ⓛ	D01-09-019
CP...-OCE	BD BL 200	Ⓜ	D01-09-019
CP...-PCE	BD BL 200	Ⓜ	D01-09-019
CP...-OCE	BF BL 500	Ⓜ Ⓜ	D01-09-019
CP...-ACE	BD BL 200	Ⓜ	D01-09-019
LE...-OCE	BC BL 100	Ⓛ	D01-09-019
LE...-OCE	BD BL 100	Ⓛ	D01-09-019
LE...-OCE	BD BL 200	Ⓜ	D01-09-019
LE...-OCE	BF BL 500	Ⓜ Ⓜ	D01-09-019
GC...-OCE	BC BL 100	Ⓛ	D01-09-019
GC...-OCEV1	BD BL 100	Ⓛ	D01-09-019
GP...-OCE	BD BL 200	Ⓜ	D01-09-019

SARTORIUS AG declares that its weighing instrument types comply with the requirements of the Council Directive on non-automatic weighing instruments, no. 90/384/EEC of 20 June 1990; the associated European Standard "Metrological aspects of non-automatic weighing instruments," No. EN 45501; the amended, currently valid versions of the national laws and decrees concerning legal metrology and verification in the Member States of the European Union, the EU, and the Signatories of the Agreement on the European Economic Area, which have adopted this Council Directive into their national laws; and with the requirements stipulated on the Type-Approval Certificate for verification. This Declaration of Type Conformity is valid only if the ID label on the weighing instrument has the CE mark of conformity and the green metrology

Sartorius AG  
37070 Goettingen, Germany  
Signed in Göttingen, 12.07.2004

Dr. G. Maaz  
(President of the Mechatronics Division)

sticker with the stamped letter "M" (the two-digit number in large print stands for the year in which the mark has been affixed):



If these marks are not on the ID label, this Declaration of Type Conformity is not valid. Validity can be obtained, for example, by submitting the weighing instrument for final action to be taken by an authorized representative of SARTORIUS AG. The period of validity of this Declaration of Type Conformity shall expire upon any tampering with, repair or modification of this weighing instrument or, in some Member States, on the date of expiration. The operator of this weighing instrument shall be responsible for obtaining an authorized renewal of the verification, such as subsequent or periodic verification, of the weighing instrument for use as a legal measuring instrument.

J. Reinwald  
(Head of the Production Department  
Mechatronics / Weighing Technology Division)

OAW-113-2/02.96  
P106ea04.doc

# Physikalisch-Technische Bundesanstalt

Braunschweig und Berlin

**PTB**



## EG-Bauartzulassung

*EC type-approval certificate*

Zulassungsinhaber: Sartorius AG  
*Issued to:* Weender Landstraße 94 – 108  
37075 Göttingen  
Bundesrepublik Deutschland

Rechtsbezug: § 13 des Gesetzes über das Mess- und Eichwesen (*verification act*)  
*In accordance with:* vom/dated 23. März 1992 (BGBl. I S. 711) in Verbindung mit Richtlinie  
(*in connection with council directive*) 90/384/EWG, geändert durch (*amended by*) 93/68/EWG

Bauart: Nichtselbsttätige elektromechanische Waage  
*In respect of:* *Nonautomatic electromechanical weighing instrument*  
BC BL 100, BD BL 200, BF BL 500

I	Max 50...320 g,	e = 1...5 mg,	n ≤ 320000
II	Max 1...34000 g,	e = 0,01...5 g,	n ≤ 52000
III	Max 100...34000 g,	e = 1...50 g,	n ≤ 10000

Option: Mehrteilungswaage /  
*multi-interval instrument*

Zulassungsnummer: **D01-09-019 1. Revision**  
*Approval number:*

Gültig bis: 2011-09-03  
*Valid until:*

Anzahl der Seiten: 9  
*Number of pages:*

Geschäftszeichen: 1.14 – 02000687  
*Reference No.:*

Benannte Stelle: 0102  
*Notified Body:*

Im Auftrag  
*By order*

Braunschweig, 2002-05-28

Siegel  
*Seal*

Link



Die Hauptmerkmale, Zulassungsbedingungen und Auflagen sind in der Anlage enthalten, die Bestandteil der EG-Bauartzulassung ist. Hinweise und eine Rechtsmittelsbelehrung befinden sich auf der ersten Seite der Anlage

*The principal characteristics, approval conditions and special conditions, if any, are set out in the Annex which forms an integral part of the EC type-approval certificate. For notes and information on legal remedies, see first page of the Annex.*



**Plates and Markings**

Types BC BL 100, BD BL 200

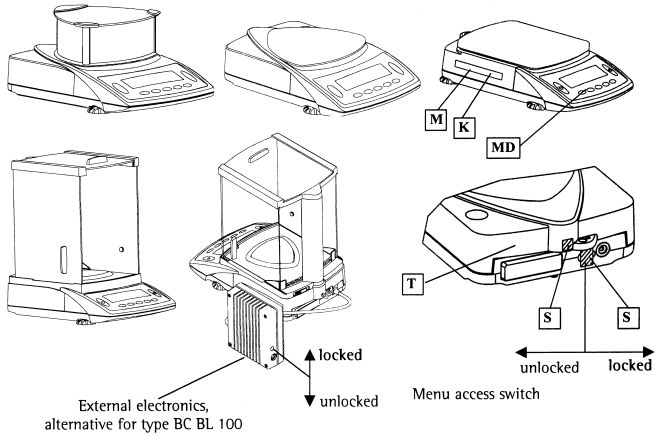

Type BF BL 500

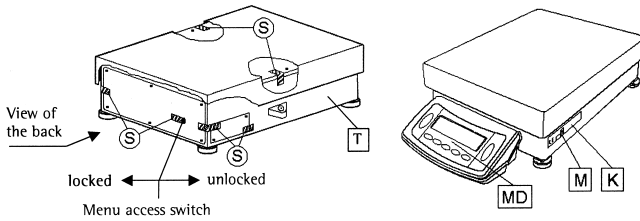

- K** Descriptive plate with CE mark of conformity
- M** Mark for EC verification (green metrology sticker)
- S** Protective seal, for accuracy classes  $\text{II}$  and  $\text{III}$  only
- MD** Metrological data
- T** Plate with model designation

**Example of descriptive plate on a weighing instrument already verified** **K**



**Example of plate with model designation** **T**



Type: BC BL 100, BD BL 200, BF BL 500  
EC type-approval certificate D01-09-019

Sartorius AG  
Weender Landstrasse 94–108  
37075 Goettingen, Germany

Phone +49.551.308.0  
Fax +49.551.308.32 89  
[www.sartorius.com](http://www.sartorius.com)

Copyright by Sartorius AG,  
Goettingen, Germany.  
All rights reserved. No part  
of this publication may  
be reprinted or translated in  
any form or by any means  
without the prior written  
permission of Sartorius AG.  
The status of the information,  
specifications and illustrations  
in this manual is indicated  
by the date given below.  
Sartorius AG reserves the  
right to make changes to the  
technology, features,  
specifications and design of the  
equipment without notice.

Status:  
July 2004, Sartorius AG,  
Goettingen, Germany

Printed in Germany on paper that has been  
bleached without any use of chlorine  
W3A000 · KT  
Publication No.: WCP6001-e04071